

MAINTENANCE MANUAL

and

INSTRUCTION BOOK

for

THE FAMOUS
JAMES

Series 10.D.

AND

Series 6. E.

**LIGHTWEIGHT
MOTOR CYCLES**

THE JAMES CYCLE CO. LTD.
BIRMINGHAM, ENGLAND.

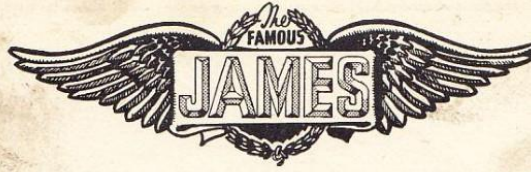

MAINTENANCE MANUAL

and

INSTRUCTION BOOK

for

THE FAMOUS
JAMES

Series 10.D.

AND

Series 6. E.

**LIGHTWEIGHT
MOTOR CYCLES**

THE JAMES CYCLE CO. LTD.

BIRMINGHAM, ENGLAND.

INDEX—JAMES SECTION

	Page
INTRODUCTION	3
DATA	4
CONTROLS	5
LUBRICATION	6
LUBRICATION CHART	7
TRANSMISSION	8
FRONT FORK DETAILS	9
WHEELS AND BRAKES	10—11
FRONT HUB	12—13
REAR HUB	14—15
GIRDER FRONT FORK	16—17
TELESCOPIC FRONT FORK	18—19
FRAME, 6E MODEL	20—21
FRAME, 10D MODEL	22—23
GENERAL DETAILS	24 to 26
TIRE SERVICE	27 to 29
TOOLS	30

FOR ENGINE DETAILS SEE SEPARATE INDEX AT END OF
MANUAL

CONTROLS

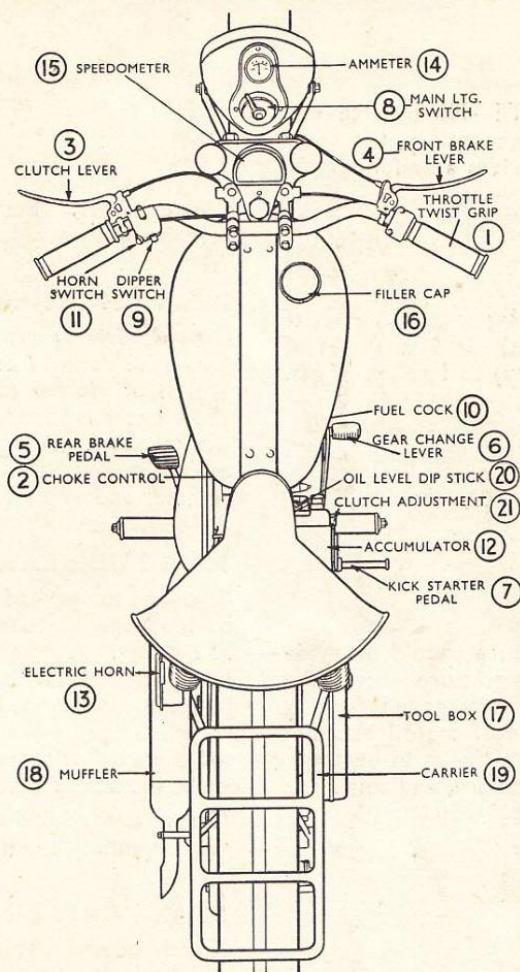

Before using a machine which may be new and strange, become familiar with the operation and position of the following controls :—

1 TWIST GRIP THROTTLE.

Twist inward to open.

2 CHOKE CONTROL 122cc. 10D.

This is operated by rotating the slide by means of the tab provided and to close the choke the tab should be pressed downwards.

When the engine is started, rotate the slide in the opposite direction by pulling the tab upwards. The tab is situated on the inner or left side of the choker body, the choke should only be used when starting from cold.

2a CARBURETTER CONTROLS.

The carburetter fitted to the 6E engine has separate controls to the throttle and the taper needle. The taper needle should be raised by this control as far as possible by moving to the rich position until the engine is warmed up, after which it must be returned to the weak position.

3 CLUTCH LEVER.

This is the large lever in front of the left hand. This lever should be operated to its full extent when changing gear.

4 FRONT BRAKE LEVER.

This is the large lever in front of the right hand grip to operate front wheel brake.

5 REAR BRAKE PEDAL.

Depress by left foot to operate rear wheel brake.

6 GEAR CHANGE LEVER.

This is the lever situated on the right hand side in front of

the kick start. To engage low gear pull lever up with toe. To engage second gear lever, push down one notch and to engage high gear, push down again. For engaging low gears, the reverse procedure should be adopted. There is no mark for the neutral position which is situated between low and second gears. When starting from a standstill do not have the engine running fast, when engaging bottom gear. The slower the engine runs the easier the gear will slide in.

7 KICK STARTER PEDAL

This is situated on the right hand side of the machine, it is fitted with a hinged pedal which folds in when machine is being ridden.

8 LIGHTING SWITCH

Controls head and tail lamps ; by turning the indicator to position H (to the right) will give full riding light. By turning indicator to position L operates the parking light.

9 DIPPER SWITCH.

The dip of the head lamp is controlled by Switch 9, situated on the left hand of the handlebars.

10 FUEL COCK.

The fuel is supplied to the carburetter by pulling out the round end of the cock. Always make a practice of turning off the fuel supply when stopping the engine, by pushing in the fuel cock tap.

11 On no account should the machine be used without muffler as this will spoil the performance of the engine. The muffler is necessary if the greatest possible power is to be obtained.

LUBRICATION

TANK CAPACITY.

Gas Tank $2\frac{1}{2}$ gallons approx. (NOTE—No balance feed pipe is fitted as it has been found unnecessary, the small quantity remaining in one side provides a useful reserve supply.)

GAS AND OIL MIXTURE.

1 part oil 30 S.A.E. winter, 40 S.A.E. summer, to 16 parts of gas, or ($\frac{1}{2}$ pint oil to 1 gallon of gas), or 4 measures of oil (measure incorporated in filler cap) to 1 gallon of gas.

RECOMMENDED OILS.

Mobiloil A, Castrol XL, Essolube 40, Double Shell, Energol S.A.E.40.

LUBRICATION.

It is preferable that the gas-oil mixture should be made before putting into the tank. The mixture enters the engine crankcase by way of the carburetter, and during the cycle of operations, a proportion of the oil becomes separated from the gas and lubricates the main bearings, connecting rod, big end and cylinder bore, and small end of connecting rod.

If the engine is to be left standing, it is advisable to turn off the fuel supply and allow the engine to use up the supply of gas oil mixture in the carburetter while coming to rest. If left standing with the float chamber of the carburetter full of gas oil mixture, the oil settles to the bottom of the float chamber. Emptying the carburetter before putting machine away avoids possible re-starting difficulties.

REAR CHAIN LUBRICATION.

The rear driving chain should be removed for lubrication. Clean the chain in kerosene, drain and wipe. Immerse in a bath of molten tallow, leave for several minutes and allow excessive lubricant to drain off and then replace on the machine. A graphited oil can be used in place of molten tallow. Lubricate rear chain every 2,000 miles in summer and every 1,000 in winter.

HUB LUBRICATION.

The hubs are packed with grease during assembly in order to lubricate the bearings and prevent the entry of mud and water. A grease nipple on the hub is provided for the periodical injection of fresh grease. The quantity injected should not be excessive. One or two shots of the grease gun will be sufficient, or there will be a tendency for the surplus to work out into the brake drum and so cause inefficient braking.

Grease every 5,000 miles or more often under extremely wet or muddy conditions.

BRAKE CAM LUBRICATION.

A little oil should be given at the point between the lever and brake cover plate (illustrated), using oil can with a good lubricant. Whilst doing this it is advisable that the brake lever should be operated so as to assist the oil to penetrate.

BRAKE PEDAL LUBRICATION.

The brake pedal is mounted on a separate shaft attached to the frame, and two nipples are provided for lubrication. See No. 4 on oil chart.

BRAKE ROD JOINT LUBRICATION.

Apply a few drops of lubricating oil on the brake lever roller (see 11, illus. 1) through which the rod passes, also on the thread of the brake rod 8 (illus 1). Apply a few spots of oil where it is attached to the brake pedal.

FORK LUBRICATION (Central Spring Type).

Nipples are provided for each shaft. Use grease S.A.E.140. Make sure that the grease gets home and that each shaft is free in its respective lug. Refer to Illustration No. 2.

HANDLEBAR CONTROL LEVER LUBRICATION.

Apply a drop of engine lubricating oil on all moving parts of the handlebar levers.

STAND FIXING BOLT LUBRICATION.

A few drops of lubricating oil should be applied to the pivot bolts of the stands. No. 7, Illustration 1.

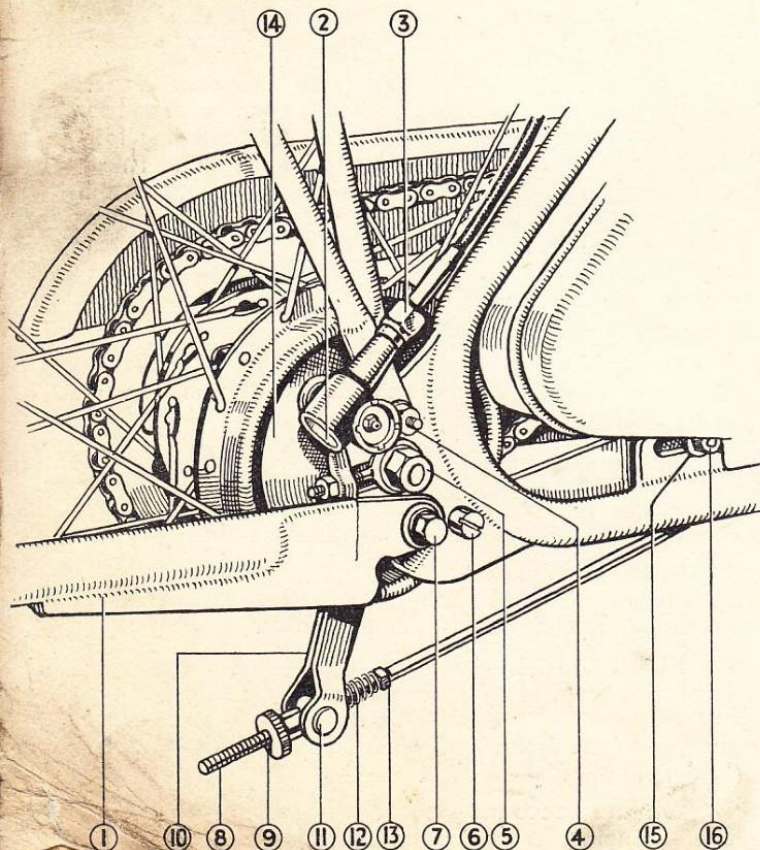
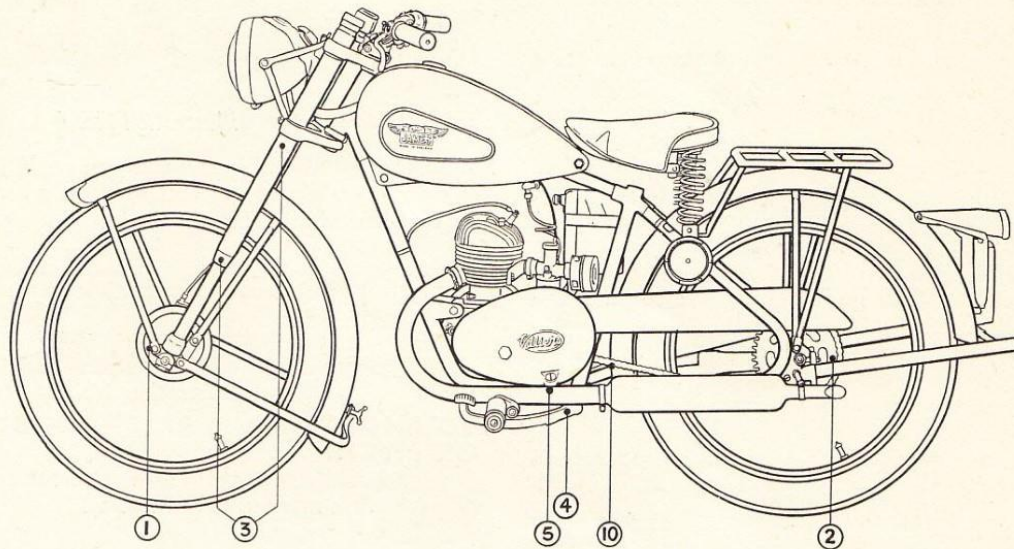

Illustration No. 1

GENERAL LUBRICATION CHART



Key No.	PART	
1	Front Hub	Light Grease
2	Rear Hub	Light Grease
3	Fork Shafts	Light Grease
4	Brake Pedal Shaft	Light Grease
5	Front Chaincase	S.A.E. 140
6	Gear Box	weight oil

OIL CAN LUBRICATION

7	Rear Brake Lever Roller	Oil
8	Gear Control Cable	Oil
9	Throttle Control	Oil
10	Rear Chain	Oil
11	Prop Stand	Oil
12	Kick Start Pedal	Oil
13	Brake Cams Front and Rear	Oil

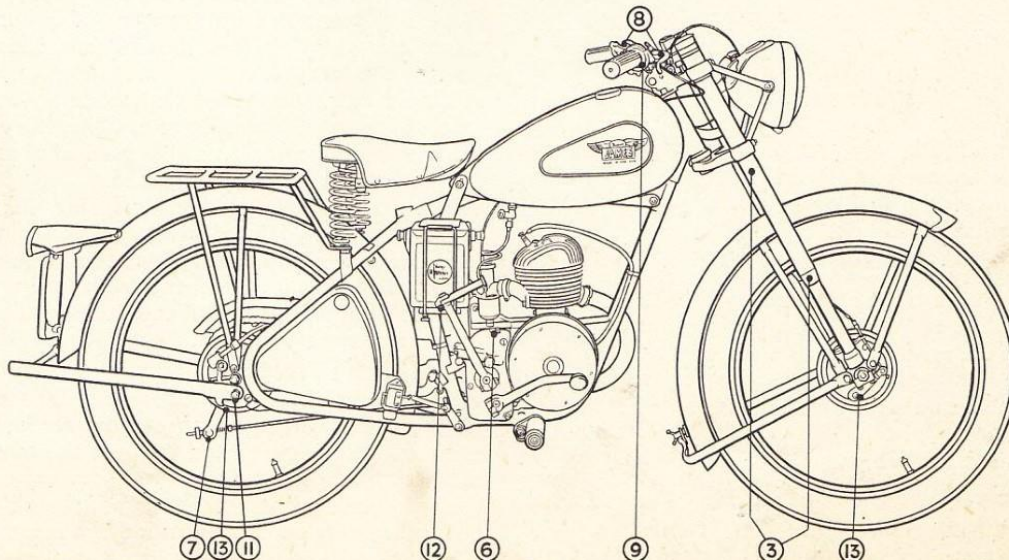

TRANSMISSION

REAR CHAIN is .5 x .335 x 108 pitches for 10.D.
.5 x .335 x 111 pitches for 6.E.

CHAIN ADJUSTMENT.

A detachable spring clip is used to secure the connecting link on the outer side of the chain. When re-fitting care must be taken to see that the open end of the spring clip faces forward when on the bottom run of the chain. To adjust the chain, release the brake anchor arm by slacking off the securing bolt, (No. 16, illus. 1). The two spindle nuts (No. 5, illus. 1) should be slacked off and the chain tensioned correctly by tightening the chain adjuster nuts, (No. 2, illus. 1), until there is approx. $\frac{3}{8}$ " slack in the chain. Care must be taken to see that the wheel is central in the rear portion of the frame. After this adjustment has been carried out and the wheel nuts tightened, the position of the wheel in the chain stay fork should be checked by measuring the distance on each side of the rim to the chain stay, on the front end. The distance of course, should be equal. Then tighten up the chain stay brake anchor arm by means of pin (15, illus. 1), re-adjust brake operating lever by the knurled nut (9, illus. 1) on the brake rod so as to obtain the correct tension.

CHAIN ALTERATIONS AND REPAIRS.

A chain seldom breaks if kept in correct adjustment and lubricated at given periods. It is usually worn out long before breaking point is reached. The rear chain, being the most heavily stressed is a most likely source of trouble and spare parts should be carried to enable a repair to be made on the road, with the aid of a rivet extractor (see illus. 3).

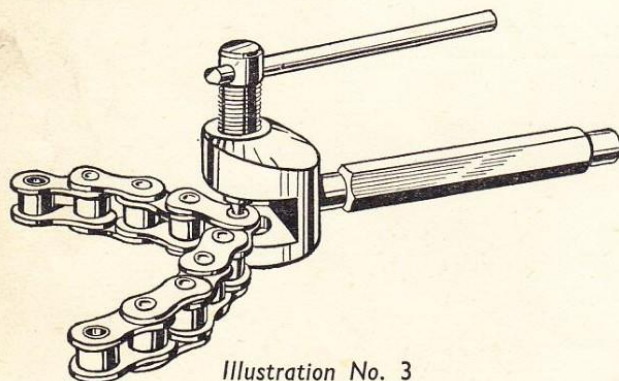

Illustration No. 3

In addition to possible breakage repairs it may be necessary during the later stages of its useful life to shorten the rear chain by removing a half or whole link in order to obtain correct adjustment.

CHAIN RIVET EXTRACTOR.

The use of this tool is clearly outlined in illus. 3. It will be observed that the chain roller is placed in between the jaws so that the uppermost nearside plate of the chain is supported on the ends of the jaws, and by then screwing down the punch the head of the rivet is forced through the uppermost outer plate. When a link has been so dismantled, it is not advisable to use it again.

CHAIN REPAIRS.

To repair a chain having a broken roller or defective link (defective parts marked A in illus. 4) extract the rivet marked B so that the damaged link, heavily shown in black, is detached.

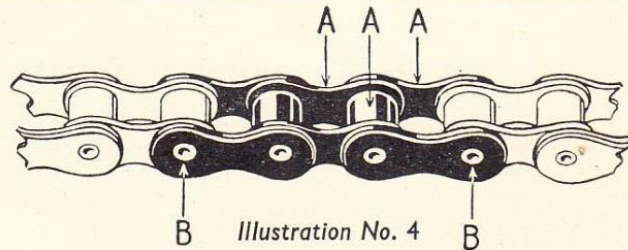

Illustration No. 4

The damaged assembly can then be replaced by one inner link and two single connecting spring links as shown in heavy black in illus. 5.



Illustration No. 5

TO SHORTEN A REAR CHAIN BY ONE LINK OR PITCH.

One end of the rear chain always terminates in a cranked link (see link marked C in illus. 6).

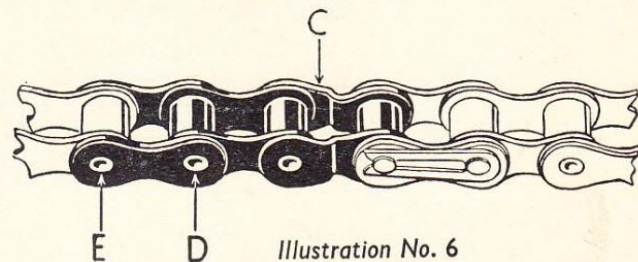

Illustration No. 6

To shorten such a chain by one link, first remove the connecting spring link that joins the two ends of the chain, then taking that end of the chain which terminates in the cranked link, extract the second and third rivets from the end marked D and E in illus. 6. That action will release the cranked link having between them, three rollers. The discarded parts should be replaced by one inner link and two single connecting spring links as shown in illus. 5. The discarded assembly consists of a complete cranked link and can be retained for further use. Note that a cranked link consists of an inner link and an outer cranked link (see illus. 6) and those parts should never be separated.

It should be remembered that, once a rivet has been extracted it cannot be used again. Therefore, before operations are commenced, make sure the correct rivet as detailed above is being extracted.

When fitting single connecting spring links, use care not to force the two fixed rivets away from one another. Also the spring clip that retains the loose side plate must be fitted so that its open end faces forward when on the bottom run of the chain and it must fit snugly in the grooves of the two rivets.

CHAIN FITTING.

When fitting a new rear chain, disconnect the old chain, at the rear wheel sprocket, by removing the single connecting spring link and connect the new chain to the old with link.

Then, by pulling the bottom run of the old chain, the new one can readily be carried round the inaccessible gear box sprocket, whereupon the old chain is disconnected and the ends of the new one connected together (see para. re adjustment).

FRONT FORK DETAILS

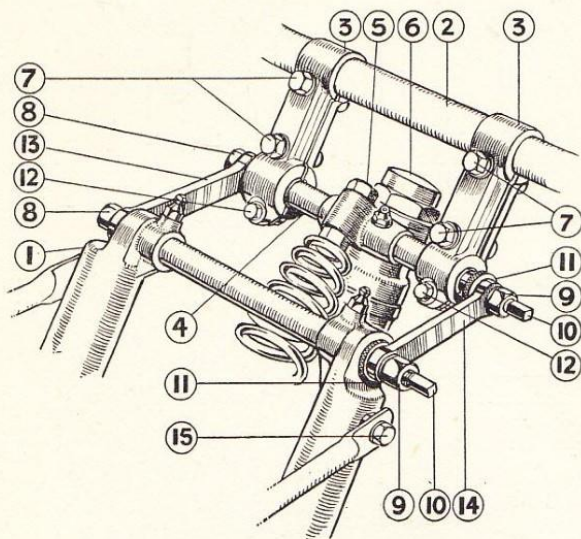

Illustration No. 2

KEY TO ILLUSTRATION No. 2. CENTRAL SPRING GIRDER FORK

1. FORK GIRDER.
2. HANDLEBAR.
3. HANDLEBAR BRACKETS.
4. FORK HEAD CLIP.
5. FORK SPRING.
6. HEAD LOCKNUT.
7. HANDLEBAR CLAMP PINS.
8. FIXED FORK SHAFT NUTS.
9. FORK SHAFT ADJUSTING NUTS.
10. FORK SHAFTS.
11. KNURLED ADJUSTING WASHERS.
12. HANDLEBAR BRACKET CLIP PINS.
13. FORK LINK FIXED.,
14. FORK LINK, ADJUSTING.
15. LAMP BRACKET FIXING PIN.

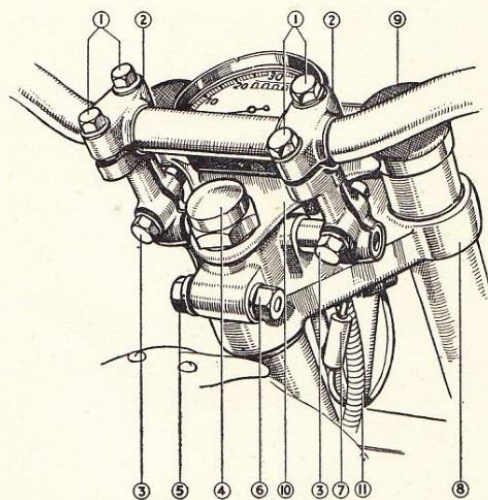

Illustration No. 2A

KEY TO ILLUSTRATION No. 2A. RUBBER SUSPENSION TELESCOPIC FORK

1. HANDLEBAR CLAMP PINS.
2. HANDLEBAR BRACKETS.
3. BRACKET CLAMP PINS.
4. HEAD LOCKNUT.
5. HEADCLIP BOLT.
6. HEAD CLIP BOLT NUT.
7. CABLE CONNECTOR.
8. TOP TWIN CLIP.
9. FORK CAP.
10. SPEEDOMETER MOUNTING PLATE.
11. SPEEDOMETER CABLE.

WHEEL & BRAKE SERVICE

FRONT HUBS.

Press-in type ball races are fitted to this hub, with adjustable cones which are screwed $\frac{1}{2}$ " x 26 thread, and have two milled flats to allow for the adjusting spanner to be used. The adjusting cone is on the right hand side of the machine, and the fixed cone on the left hand side.

The ball races are fitted with 20 $\frac{5}{16}$ " ball bearings, 10 on each side of the hub. There is no adjustment for the ball bearings cups.

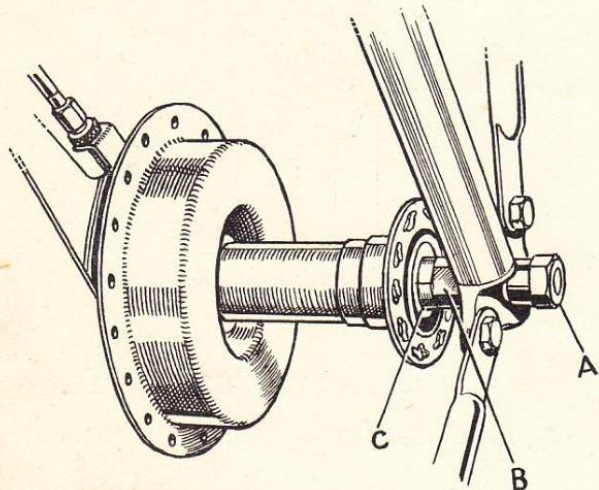

Illustration No. 7

REMOVAL OF WHEELS.

The stands give sufficient clearance for the removal of the wheels.

To remove the front wheel, disconnect the cable from the front brake arm, after slackening the adjuster. Then release spindle nuts (A, illus. 7).

The front wheel can be easily removed from the front fork ends.

To remove the rear wheel, disconnect the rear chain connecting link and allow the chain to hang at the gearbox end still remaining on the front drive sprocket. Remove the knurled nut from the brake rod (9, illus. 1), then remove the rear brake anchor plate pin nut (16, illus. 1), take off the pin (15, illus. 1). Slacken the two spindle nuts (5, illus. 1), then slide the wheel backwards from the fork ends. Reverse the operation to replace the rear wheel.

METHOD OF FITTING FRONT WHEEL INTO THE JAMES TELESCOPIC FORKS.

First, put mudguard in position and fix with screws into the ears which are cast on to the fork ends. Now, insert the wheel into the fork ends with the locking nut (6, illus. 7A), which is situated adjacent to the brake. Next, put on the two end caps, 7 and 7L, and lightly tighten into position.

Tighten up the locking nut, tighten up the cap (7) to the locking nut (6), bounce the machine once or twice which will equalise the front wheel in the fork, and then tighten the other end cap. Check end caps for tightness, and then fit brake cable (13) by passing the cable through the hole provided (14) in the brake anchor arm and fit the nipple into the roller (11) of the brake arm (10), adjust by screwing back the front brake cable adjuster (15).

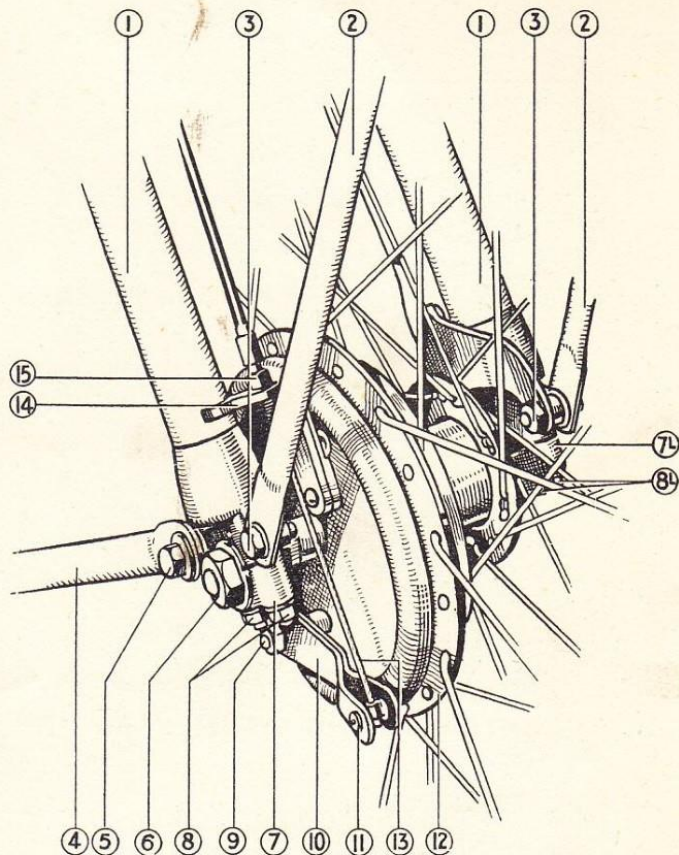

Illustration No. 7A

WHEEL ALIGNMENT.

To check wheel alignment a thin piece of string stretched taut across both wheels, with front wheel in straight ahead position about 4" from and parallel to the ground, should just touch each tire at both sides of the wheel centre.

An alternative method of checking wheel alignment is to procure a plain board approximately 6' x 3" x $\frac{3}{4}$ " thick. Make sure the edge is perfectly straight. Place the edge of the board alongside the wheels so that it touches each one. If necessary, turn the handlebars so that the front wheel touches the board at two points. If the wheels are in correct alignment the board will then come in contact with the rear wheel at two points. If, however, this is not the case, slack off the rear wheel spindle nuts and brake anchor clip pin and nut and adjust by the chain adjuster nut until the rear wheel is in the correct position. The rear wheel must be in the centre of the chain stays.

WHEEL BEARING ADJUSTMENT.

After a running-in period of approximately 200-300 miles it is advisable to examine the wheel bearings and take up any play necessary.

The adjustment can be carried out without removing the wheels, and is done in the following manner:—

Release spindle lock nut and cone lock nut which will allow cone to be turned until the play in the bearing has been taken up.

The adjustment should be made until there is no side play in the wheel, which is felt by rocking the rim, at the same time the wheel must be allowed to revolve freely

WHEEL & BRAKE SERVICE—contd.

on its bearings. Now, tighten lock nut against the face of cone, so that cone cannot move.

Again, check wheel alignment, to see that this has not been altered. Afterwards, re-tighten spindle lock nut. This operation is carried out on both front and rear wheels, from the right hand side of the machine.

TO DISMANTLE WHEEL BEARINGS.

Front Wheel.

Remove front wheel from forks. Remove spindle end nuts (17, illus. 8). Withdraw cover plate, care to be taken to see that no packing washers are lost.

Remove adjusting cone peg washer (22, illus. 8), and then adjusting cone (21, illus. 8), and withdraw spindle from the brake side, taking care that none of the loose ball bearings are lost.

Examine cones, cups and ball bearings for wear. Replace if necessary.

To Replace Ballrace Cups.

To replace the ballrace cups proceed in the following manner :—

Use a bar long enough to go through the centre barrel of the hub and tap the hub cup (No. 4, illus. 8) at equal points to release this from its seating and continue until cups and dust cap (4 and 3, illus. 8) are removed. Reverse the hub and the opposite cup and dust cap can be removed in a similar manner.

When fitting new cups, press the cups firmly into seating, making sure that they are pressed home evenly. Replace the dust cap and if the end of the hub is pressed over lightly with a hammer it will ensure the cap being secured.

To re-assemble, reverse the operation. Pack the cups with grease and fit the bearings into the cups (the balls will hold in place with the grease) before replacing the spindle and cones.

Before fitting peg washer care must be taken when assembling the spindle that the adjusting cone (21, illus. 8) is adjusted so that there is no side play, but the wheel revolves freely.

Rear Wheel.

Remove the wheel from the machine taking off the spindle nuts (20, illus. 9). Withdraw cover plate taking care that packing washers are not lost.

On the opposite side, remove adjusting cone locknut (21, illus. 9), and peg washer (22, illus. 9) and finally cone. Taking care that none of the loose ball bearings are lost. Examine cones, cups and ball bearings for wear, and replace if necessary.

To replace cups see instruction for front wheel.

Re-assemble by reversing these operations, packing the bearing cups with grease, put the ball bearings into cups before fitting spindle.

Before fitting peg washer and locking with nut (21, illus. 9), care must be taken when assembling the spindle that the adjusting cone (23, illus. 9) is adjusted so that there is no side play but the wheel revolves freely.

WHEEL BUILDING.

The front wheel is built centrally on a WMI-19 rim. Spokes must be laced so that each one crosses over three others on the left side and one over two on the brake side.

The rear wheel is built centrally on a WMI-19 rim.

Spokes must be laced so that on the brake side each spoke crosses over two others and on the left side, each spoke crosses over three others. Both front and rear wheels have 36 spokes, 18 on each side.

SPOKE SIZES.

Front Wheel.

Plain side $8\frac{11}{16} \times 10G$.

Brake side $7\frac{1}{4} \times 10G$.

90° head. Nipples .250 x 56 T.P.I.

Rear Wheel.

Plain side $8\frac{9}{16} \times 10G$.

Brake side $7\frac{1}{2} \times 10G$.

90° head. Nipples .250 x 56 T.P.I.

BRAKE SHOES.

To remove brake shoes from brake cover plate, prise the shoes out of the fixed stop by placing a screwdriver between the shoes and the cover plate and lifting upwards towards the brake cam.

When the shoes are clear of the pivot they can be taken one in each hand and the two outer edges of the brake shoes brought upwards together which will release them from the cam.

Examine brake linings for wear, and if necessary fit new linings, or replacement shoes and linings.

If new linings are fitted see that they are fitted so that they lie in close contact with the shoes, also see that the rivet heads are countersunk below the face of the linings, and that the foot of the rivet is carefully punched over.

With new linings a small bevel should be filed on the leading edge of each shoe to provide a lead for the braking action.

BRAKE PEDAL ADJUSTMENT.

This is carried out from the knurled nut (9, illus. 1) fitted on the wheel end of the brake rod.

KEY TO FRONT HUB

KEY TO HUB FOR TELESCOPIC FORK, ILLUSTRATION No. 8

1. FRONT HUB ASSEMBLY.
2. FRONT HUB LUBRICATOR.
3. FRONT HUB DUST CAP.
4. FRONT HUB CUPS.
5. BRAKE LINING RIVET.
6. FRONT BRAKE LINING.
7. FRONT BRAKE SHOE AND LINING.
8. FRONT BRAKE SHOE SPRINGS.
9. FRONT BRAKE CAM.
10. FRONT BRAKE CAM LEVER.
11. FRONT BRAKE CAM WASHER.
12. FRONT BRAKE CAM NUT.
13. FRONT BRAKE COVER PLATE.
14. FRONT BRAKE CAM BUSH.
15. FRONT BRAKE ANCHOR ARM.
16. FRONT BRAKE ANCHOR ARM RIVET.
17. SPINDLE NUTS.
18. SPINDLE WASHERS.
19. BRAKE COVER PLATE PACKING WASHER THICK.
20. FIXED CONE.
21. FRONT HUB ADJUSTING CONE.
22. FRONT HUB ADJUSTING CONE PEG WASHER.
23. FRONT HUB DISTANCE PIECE.
24. BALL BEARINGS. $\frac{1}{8}$ " DIA. 10 EACH SIDE.
25. FRONT HUB SPINDLE.

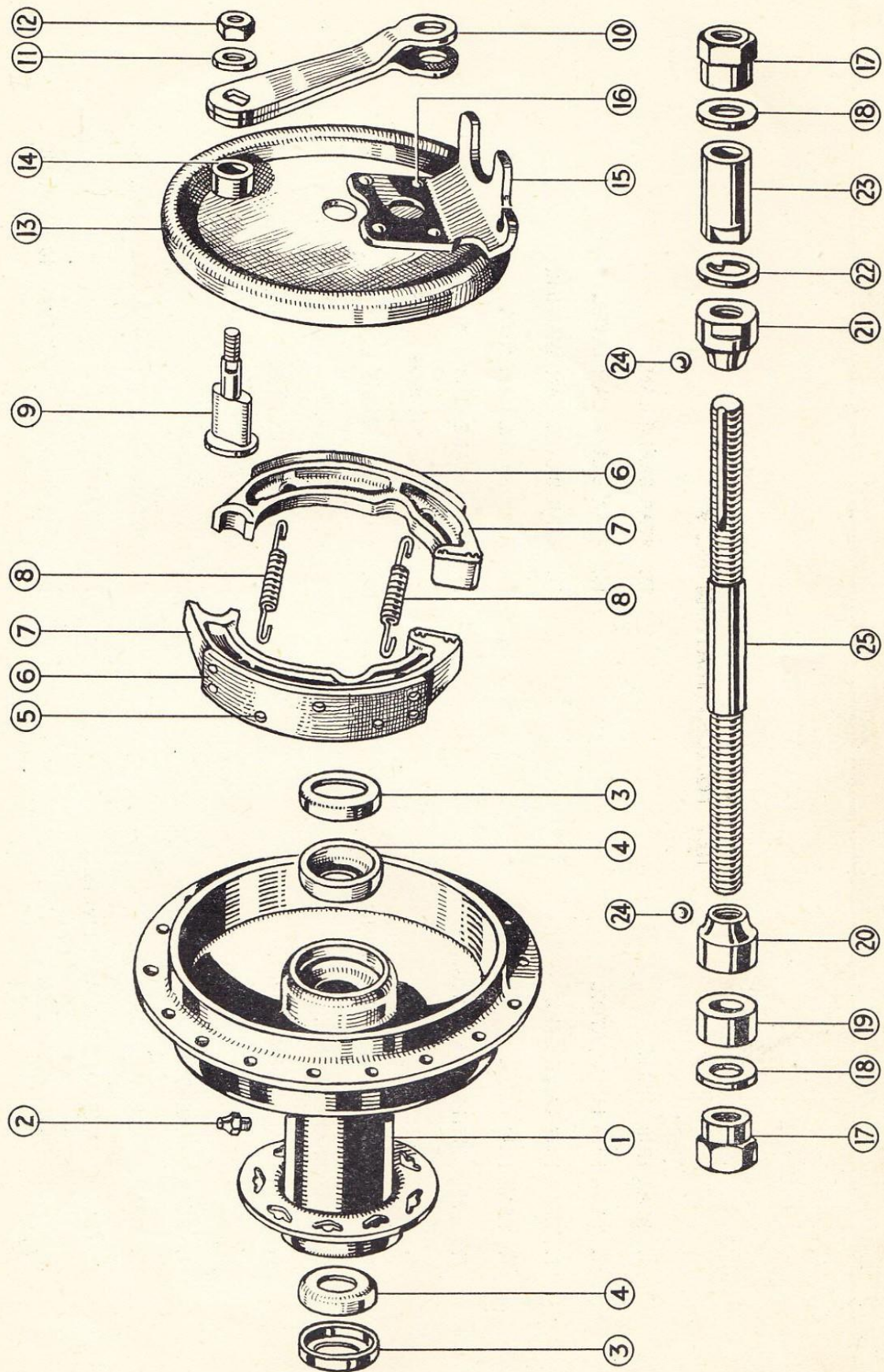

Illustration No. 8

KEY TO REAR HUB

KEY TO ILLUSTRATION No. 9

1. REAR HUB SHELL.
2. REAR HUB LUBRICATOR.
3. REAR HUB DUST CAPS.
4. REAR HUB CUPS.
5. SPEEDOMETER GEAR RING.
6. SPEEDOMETER PINION.
7. REAR BRAKE SHOE AND LINING.
8. REAR BRAKE LINING.
9. REAR BRAKE LINING RIVET.
10. REAR BRAKE SHOE SPRINGS.
11. REAR BRAKE COVER PLATE.
12. REAR BRAKE ANCHOR ARM.
13. REAR BRAKE ANCHOR ARM RIVETS.
14. SPEEDOMETER GEARBOX.
15. REAR BRAKE CAM.
16. REAR BRAKE CAM LEVER.
17. REAR BRAKE CAM WASHER.
18. REAR BRAKE CAM NUT.
19. REAR BRAKE CAM BUSH.
20. REAR HUB SPINDLE NUTS.
21. ADJUSTING CONE LOCKNUT.
22. PEG WASHER.
23. ADJUSTING CONE.
24. SPINDLE.
25. FIXED CONE.
26. DISTANCE PIECE THIN, BRAKE SIDE.
27. DISTANCE PIECE, THICK.
28. BALL BEARINGS. $\frac{5}{16}$ " DIA. 10 EACH SIDE.

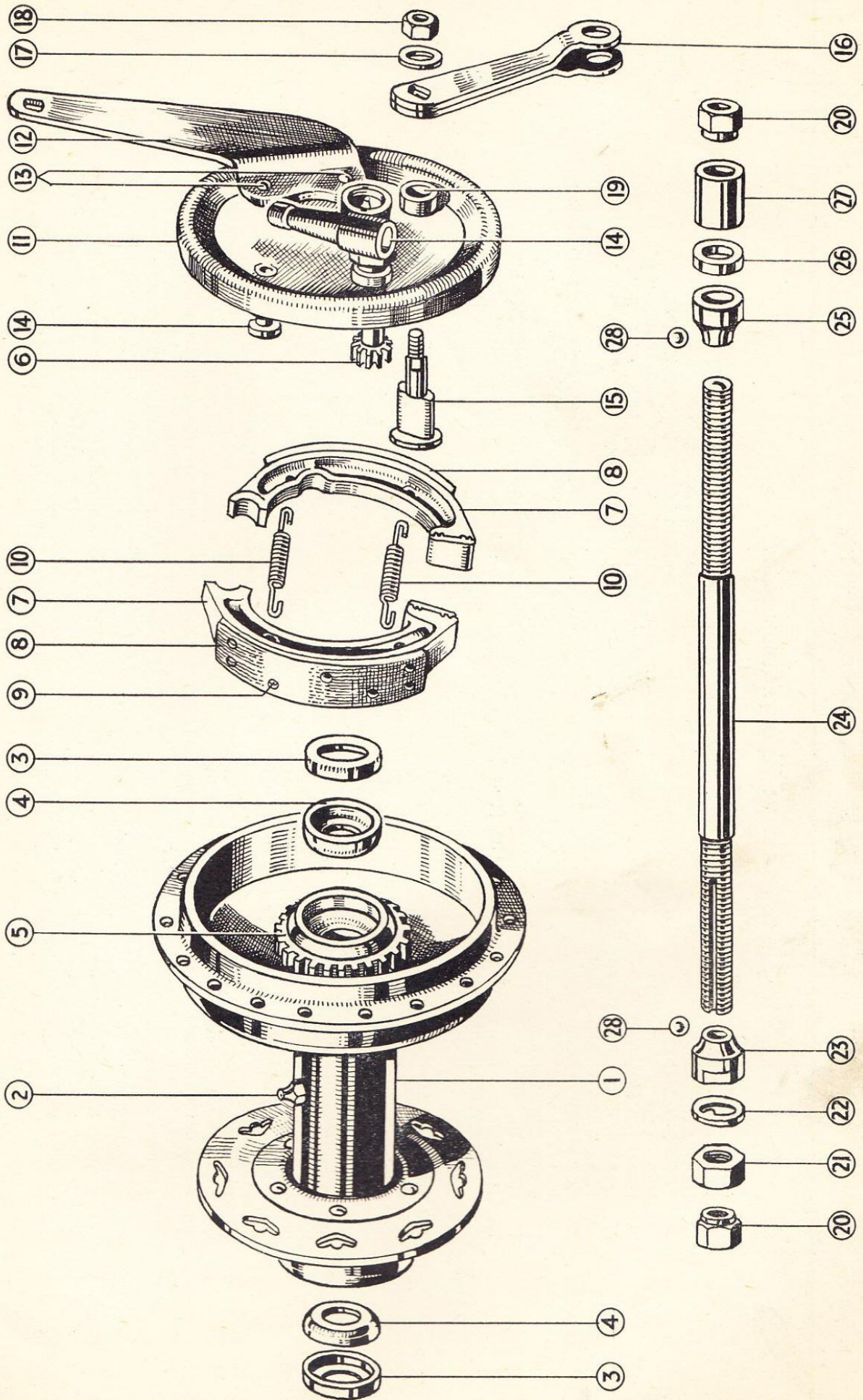

Illustration No. 9

KEY TO GIRDER FRONT FORK

KEY TO ILLUSTRATION No. 10

1. FORK GIRDER.
2. HEAD CLIP SLEEVE.
3. HEAD CLIP BOLT.
4. TOP FORK SHAFT.
5. HEAD CLIP LUBRICATOR.
6. HEAD LOCKNUT.
7. HEAD LOCKNUT WASHER.
8. FORK CROWN AND STEM.
9. TOP FRAME RACE.
10. BOTTOM FRAME RACE.
11. FORK CROWN RACE.
12. HEAD BEARING.
13. TOP FORK BRIDGE LUBRICATOR AND FORK CROWN LUBRICATOR.
14. FORK SPRING.
15. FORK SPRING PIN.
16. BOTTOM FORK SHAFT.
17. BOTTOM FORK LINK ADJUSTING.
18. KNURLED WASHER ADJUSTING SIDE.
19. FORK SHAFT NUT ADJUSTING SIDE.
20. FORK SHAFT SHAKEPROOF WASHER ADJUSTING SIDE.
21. FORK SHAFT SHAKEPROOF WASHER FIXED SIDE.
22. FORK SHAFT NUT FIXED SIDE.
23. NUT HEADCLIP BOLT.
24. SHAKEPROOF WASHER HEADCLIP BOLT.
25. FORK LINK TOP ADJUSTING.

TO REMOVE THE FRONT FORK ASSEMBLY AS A UNIT.

First, remove the front wheel. (See wheel, and brake service, page 10). Disconnect speedo cables and fuel pipe. Next, free the head lamp, the procedure for which is as follows:—

REMOVE THE TANK cover by removing the front tank bolt, taking care not to lose the $\frac{3}{16}$ " packing washers between the tank and headlug. Then remove the screws at the rear end of the tank cover.

Remove bolt from nose of saddle and the $\frac{3}{8}$ " and $\frac{5}{16}$ " bolts from front and rear ends of tank. Allow front of tank to drop forward, then lift rear end of tank clear of machine. Disconnect the lighting cables.

- (1) from the battery,
- (2) stop light switch,
- (3) tail lamp,

then draw the cables clear through the fork.

Remove the clutch, brake and gear control levers also twistgrip from the handlebars by slackening off the two $\frac{5}{16}$ " and $\frac{3}{16}$ " pins (7 and 12, illus. 2) holding the handlebar clip on to the fork head clip. Swing handlebars forward clear of head locknut which is on top of fork column. Remove head clamping bolt and tap out the two loose collars in rear of fork head clip.

It would be advisable to place something under the front fork to catch any ball bearings which might become lodged when dismantling fork. There are 21 ball bearings in the top race and 21 in the bottom.

The fork assembly may now be removed by taking off the head locknut and by gently tapping the bottom portion of the fork column with a mallet. The column can be withdrawn.

TO REMOVE FORK GIRDER ONLY.

First remove the front wheel, see previous instructions, then the lighting set, see fork assembly instructions. Slacken the nut at the top of the fork spring (5, illus. 2), but do not take it off completely.

Remove the nuts on the ends of the top and bottom fork shafts (8, illus. 2) which are on the right hand side of the machine.

Then the fork shafts can be removed completely by tapping the fork links, still assembled on the left hand side, with a mallet and a piece of wood.

The front girder is now suspended on the fork spring, so remove nut (5, illus. 2) and the girder will be free.

Having removed the girder, the dismantling can be completed by slackening the nut at the bottom of the fork spring, the spring can be taken from the girder.

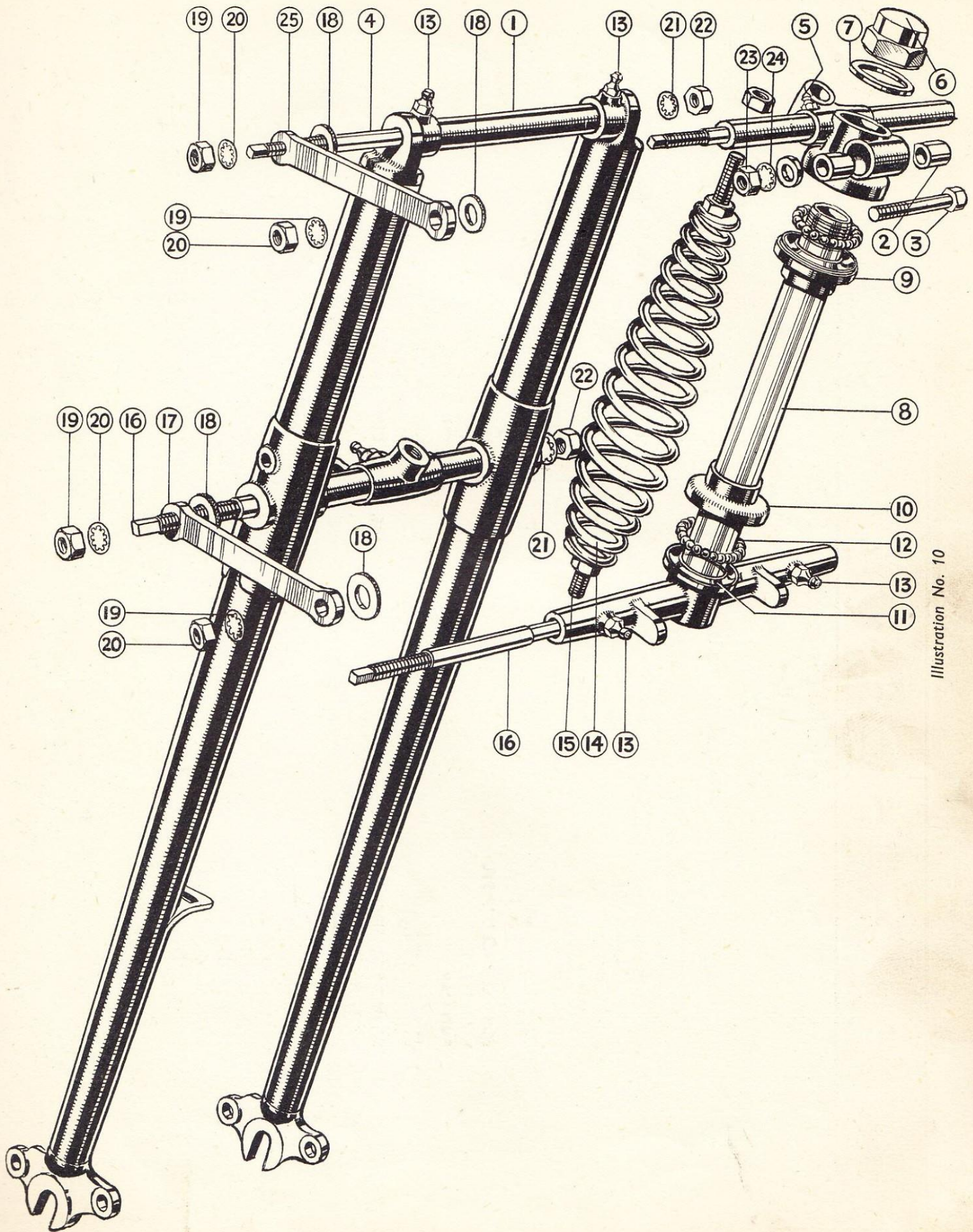

Illustration No. 10

KEY TO TELESCOPIC FRONT FORK

(RUBBER SUSPENSION)

KEY TO ILLUSTRATION No. II

1. SPRING ROD.
2. MAIN SPRING.
3. SPRING END SPACER.
4. SPRING RETAINING CAP.
5. SEATING PAD.
6. INNER STRUT.
7. FORK END CLAMP.
8. FORK END CLAMP STUD.
9. FORK END CLAMP STUD WASHER.
10. FORK END CLAMP STUD NUT.
11. END CAP.
12. TOP SEAL GASKET.
13. SIMMONDS NUT.
14. SPRING ROD FIBRE WASHER.
15. POST INNER RUBBER WASHER.
16. POST INNER BEARING.
17. POST COMPLETE.
18. TOP BEARING BUFFER.
19. SEALING WASHER.
20. STRUT OUTER PIPE.
21. LUBRICATORS.
22. BUSH SECURING PINS.
23. BOTTOM SEAL.
24. HANDLEBAR CLAMPING PIN.
25. HANDLEBAR CLAMPING PIN WASHER.
26. HANDLEBAR BRACKET.
- 26A. HANDLEBAR CLAMP.
27. HANDLEBAR BRACKET NUT.
28. HANDLEBAR BRACKET NUT WASHER.
29. HANDLEBAR BRACKET PIN.
30. TOP TWIN CLIP.
31. HEAD LOCKNUT.
32. HEAD LOCKNUT WASHER.
33. HEAD CLIP RACE.
34. HEAD CLIP CLAMPING BOLT.
35. HEAD CLIP CLAMPING NUT.
36. HEAD CLIP CLAMPING LOCKWASHER.
37. HEAD CLIP CLAMPING PLAIN WASHER.
38. HEAD CLIP CLAMPING SLEEVE.
39. BALLS.
40. TOP FRAME RACE.
41. BOTTOM TWIN CLIP AND FORK COLUMN.
42. BOTTOM FRAME RACE.
43. BALLS.
44. CROWN RACE.
45. TWIN CLIP CLAMPING STUDS.

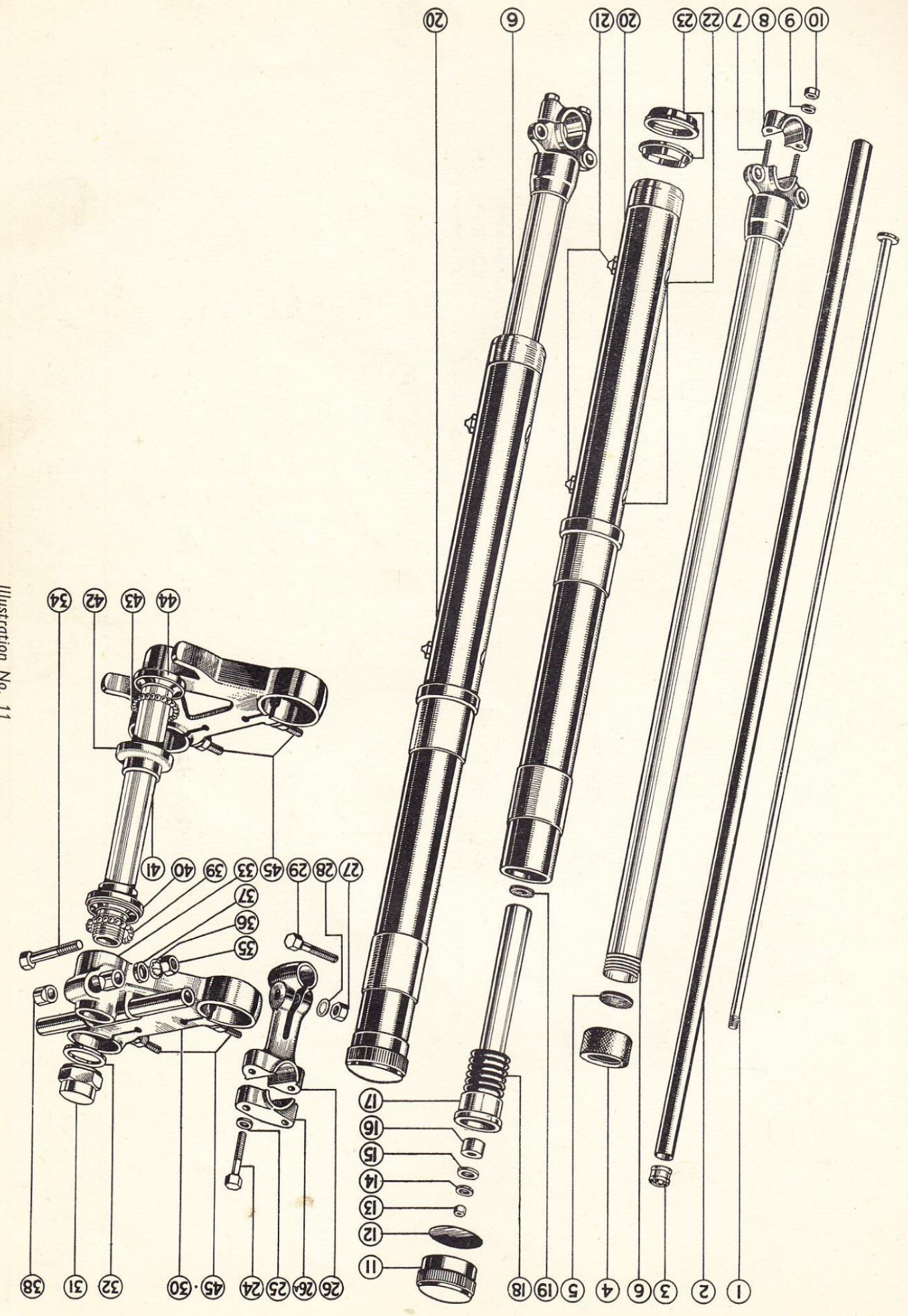

Illustration No. 11

KEY TO FRAME & TELESCOPIC FORK (6E)

KEY TO ILLUSTRATION No. 12 (FRAME WITH TELESCOPIC FORK).

1. MAIN FORK HEAD LOCKNUT.
2. MAIN FORK HEAD LOCKNUT WASHER.
3. TOP TWIN CLIP.
4. HEADCLIP SLEEVE.
5. HEADCLIP BOLT.
6. HEAD RACE TOP.
7. FRONT SADDLE AND REAR TANK FIXING LUG.
8. REAR SADDLE FIXING LUGS.
9. TOOL BOX FIXING LUGS, TOP, R.H.
10. TOOL BOX FIXING LUGS, TOP, L.H.
11. REAR MUDGUARD STAY FIXING HOLES.
12. REAR FORK ENDS.
13. REAR MUDGUARD BOTTOM FIXING BRIDGE.
14. SILENCER FIXING HOLE.
15. TOP MUDGUARD FIXING LUG, R.H.
16. TOP MUDGUARD FIXING LUG L.H.
17. REAR BRAKE ANCHOR FIXING PLATE.
18. SILENCER FIXING LUG.
- 18A. TOOL BOX FIXING LUG BOTTOM.
19. BOTTOM FRAME LUG FOR BRAKE PEDAL.
- 19A. TOP FRAME SEAT LUG.
20. FOOTREST FIXING LUG.
22. REAR ENGINE FIXING LUG.
23. STAND RETURN SPRING BRACKET.
24. BOTTOM ENGINE FIXING LUG.
25. FRONT ENGINE FIXING LUG.
26. PROP STAND STOP TUBE.
27. FORK END LUG FIXING NUT.
28. FORK END LUG FIXING STUD.
29. FORK END CLIP.
30. FORK INNER STRUT.
31. FORK OUTER STRUT.
32. FORK LUBRICATORS.
33. BOTTOM TWIN CLIP WITH COLUMN.
34. FORK CROWN RACE.
35. FORK $\frac{3}{16}$ " BALL BEARINGS.
36. BOTTOM FRAME RACE.
37. FORK STRUT CLAMPING STUDS.
38. TOP FRAME RACE.
39. BALL BEARINGS $\frac{3}{16}$ ".
40. FRAME HEAD LUG.
41. HEAD CLIP BOLT NUT.
42. HEAD CLIP BOLT WASHER (LOCK).
43. HEAD CLIP BOLT WASHER (PLAIN).
44. HANDLEBAR CLAMP.
45. HANDLEBAR CLAMP PIN.
- 45A. HANDLEBAR CLAMP PIN WASHER.
46. HANDLEBAR BRACKET PIN.
47. HANDLEBAR BRACKET PIN WASHER.
48. HANDLEBAR BRACKET PIN NUT.
49. HANDLEBAR BRACKET.
50. HANDLEBAR TOP CAP.
51. FRONT TANK FIXING LUG.

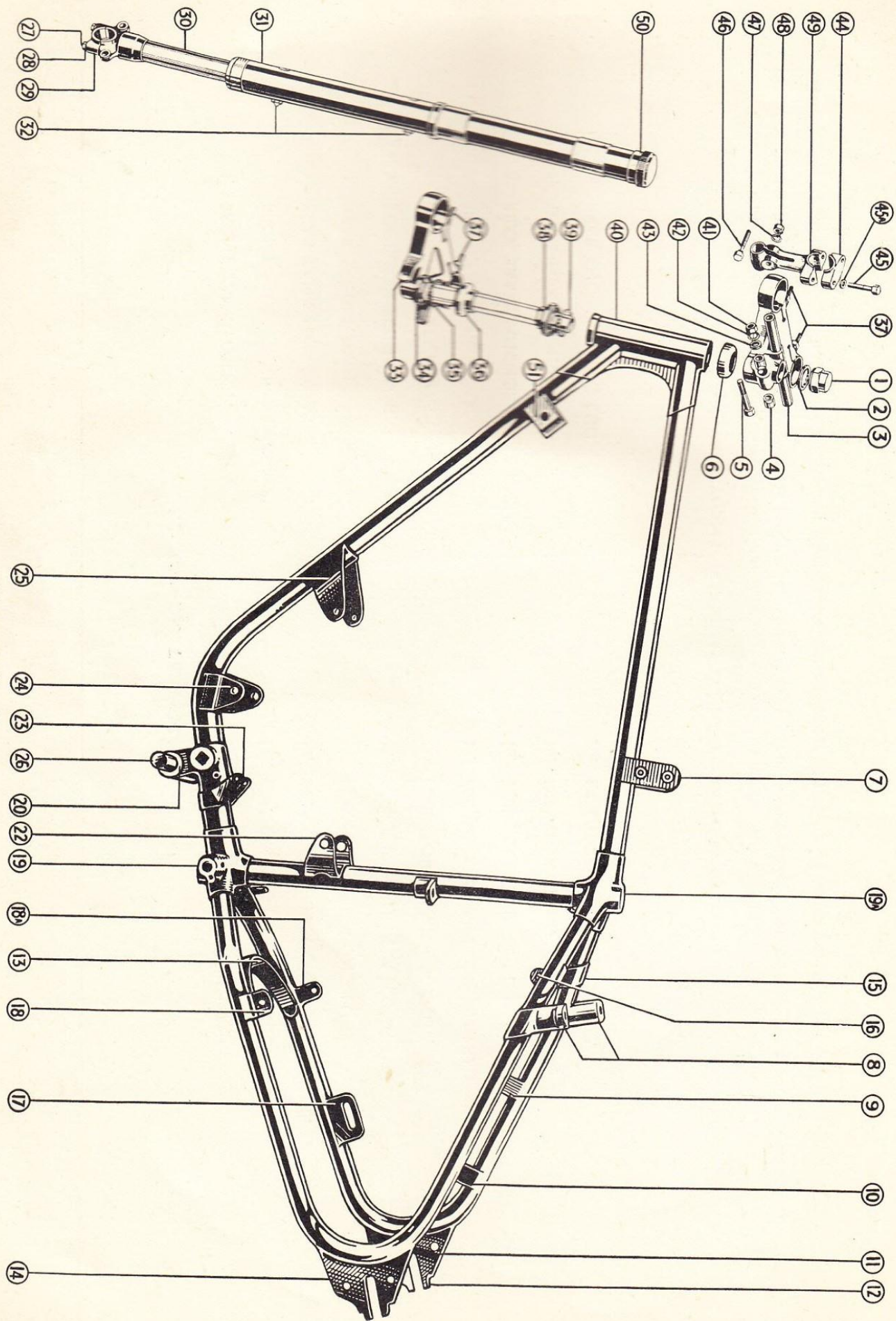

Illustration No. 12

KEY TO FRAME (MODEL 10D)

KEY TO ILLUSTRATION No. 13

- | | |
|---|------------------------------------|
| 1. FRONT TANK FIXING. | 11. FOOTREST ROD FIXING LUG. |
| 2. FRONT SADDLE FIXING LUG. | 12. BOTTOM ENGINE FIXING LUG. |
| 3. REAR TANK FIXING LUG. | 13. STAND RETURN SPRING ANCHORAGE. |
| 4. REAR SADDLE FIXING BOSSES. | 14. FRONT ENGINE FIXING LUG. |
| 5. TOOL BOX FIXING LUG. | 15. BRAKE FULCRUM PIN FIXING LUG. |
| 6. MUDGUARD STAY AND CARRIER FIXING HOLE. | 16. MAIN FORK HEAD LOCKNUT. |
| 7. SILENCER FIXING HOLE. | 17. FORK SPRING ANCHOR PIN NUT. |
| 8. REAR BRAKE ANCHOR PLATE FIXING. | 18. FORK CLAMPING BOLT. |
| 9. TOOL BOX FIXING LUG. | 19. INFLATOR FIXING STUD LOWER. |
| 10. REAR ENGINE FIXING LUG. | 20. INFLATOR FIXING STUD, TOP. |

INSTRUCTIONS FOR REMOVING FORK ASSEMBLY.

First slacken the handlebar clamping pins, swing handlebar clear of the head ; then remove the fork spring nut 17 ; release clamping bolt 18 ; remove head locknut 16. The fork is then free to be removed from the head of the frame.

Care must be taken that none of the ball bearings are lost and there should be 21 in the top race and 21 in the bottom race.

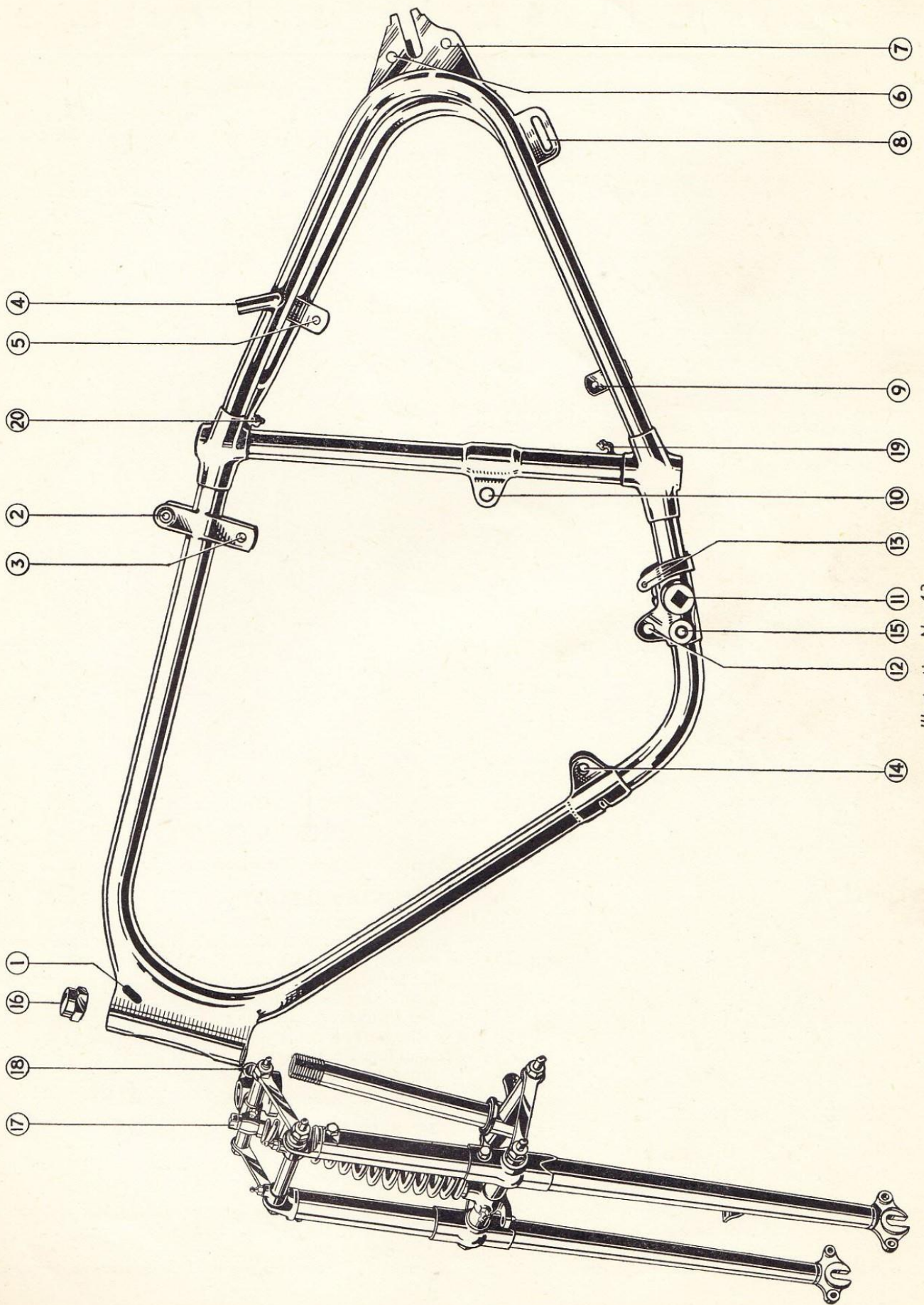

Illustration No. 13

GENERAL DETAILS

CENTRE PROP STAND.

Standard Model.

The centre prop stand is mounted on two support lugs, one R.H. and one L.H., which are situated on the footrest rod. The brake side left hand lug can be distinguished by the fact that it has a milled flat to clear the brake pedal. The prop stand is attached to the support lugs by two bolts, nuts and washers and can be removed if necessary as a unit.

Prop stand springs to bring the stand back into the disengaged position are anchored on to the top cross rod of the stand and also on the bracket fitted to the bottom frame tube.

De Luxe Model.

Front and rear individual wheel stands are provided to facilitate adjustments to wheels or tires. An additional centrally mounted strut stand can be supplied as an extra if required.

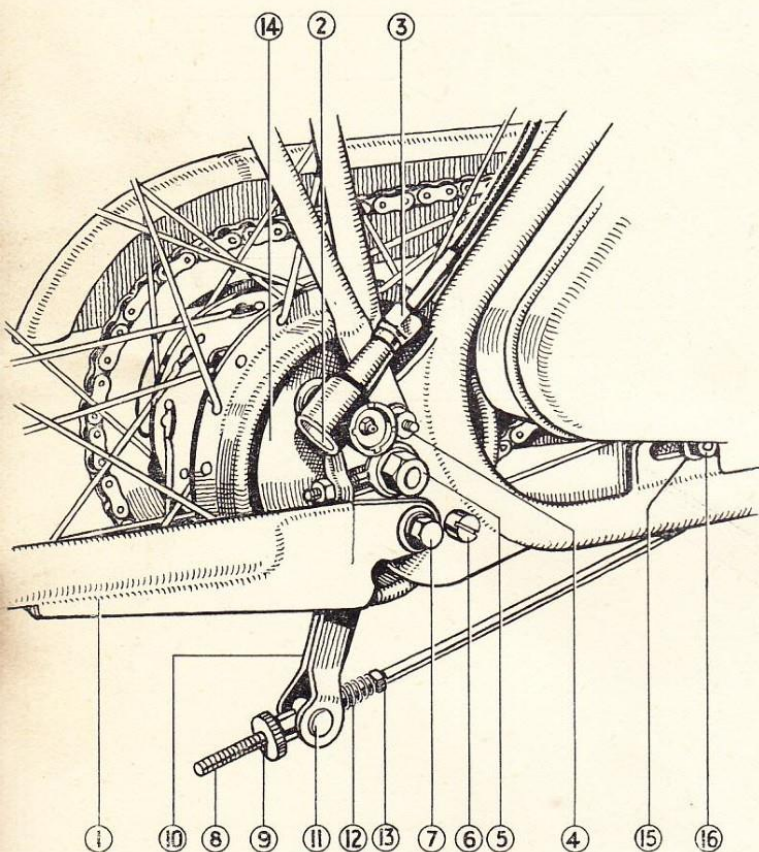

Illustration No. 1

MUFFLER.

The muffler fitted on this machine provides for a clear passage of the exhaust gases and is designed to give the utmost power output from the engine; it should not be interfered with in anyway with the exception of an occasional clean, say every 5,000 miles. To do this first remove the screw which holds the collar, then detach the complete muffler from the frame of the machine. Afterwards remove the three small screws at the tail pipe end of the muffler, pull apart and take off the old glass wool and replace with either glass wool or if this is not available,

wire wool which should be wrapped round the interior of the muffler so that no holes are exposed. See that the holes are clear of carbon.

Replace by pushing back into the body making sure that the screw holes in the end cap correspond with the small holes in the body of the muffler. Re-insert the three small screws and assemble on to the machine.

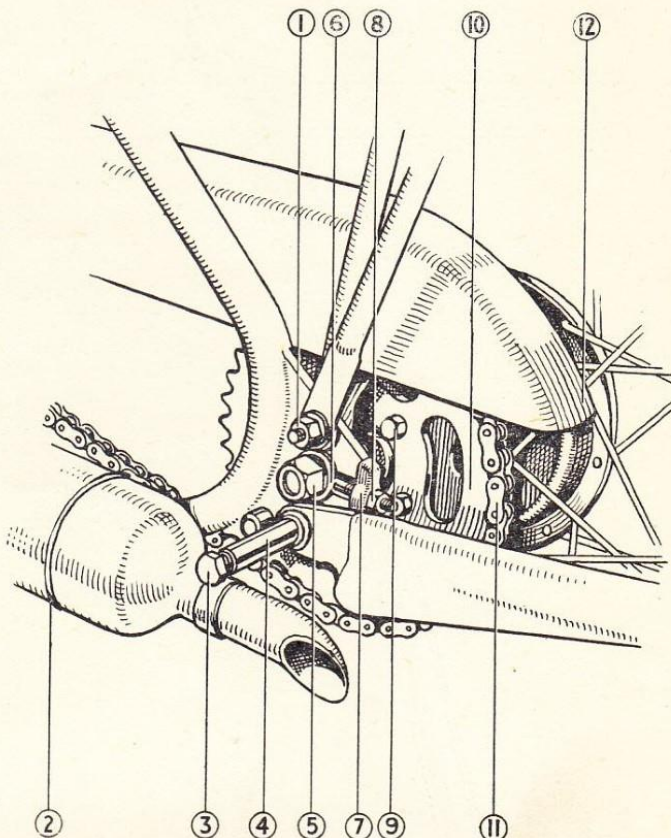

Illustration No. 14

ADJUSTABLE FOOTRESTS.

The footrests are carried on a square rod which passes through the bottom frame lug. The hangers are serrated to give varying positions. See the footrests are in line. If it is necessary to dismantle these at any time, the procedure for re-assembly is as follows:—

First fit the rod, then the right and left hand lug referred to above (which have squared holes) making sure the stand lugs are in alignment with each other. Next fit the distance tubes one on each side, and after these, the footrest hangers. Securing with the $\frac{7}{16}$ " x 26th nuts.

TO REMOVE THE FUEL TANK.

See page 16.

FILLER CAP.

The combined filler cap and oil measure for the correct quantity of oil is incorporated (4 full measures of oil to one gallon of gas).

Make sure the cap is tightened fully to prevent seepage.

GAS TAP.

The gas tap is the push-pull type. Pull outwards for on and push inwards to cut off the gas supply.

GENERAL DETAILS

TO REMOVE REAR CHAIN GUARD.

Remove pin securing front end of chainguard to mudguard complete with washer. Release bolt at chainstay fork end (1, illus. 14). There is a slotted end to the rear clip. When clear of the slot the chainguard can be brought backwards over the rear wheel sprocket.

HEAD BEARINGS.

These bearings are fitted with press-in type races and $\frac{3}{16}$ " diameter balls are fitted: 21 in the top bearing and 21 in the bottom bearing. The bearings are well packed with grease, when assembled so that no further provision is made for lubrication. The head bearings, therefore, should be dismantled and re-packed with grease every 5,000 miles.

Occasionally test the steering head for wear by placing the fingers between the fork crown race and the frame head lug, and lift from the end of the front mudguard. If any play has developed it will be felt by this method.

It is particularly important that this should be checked after the first 100 miles, because of the initial settling down of the bearings which occurs in this period.

TO ADJUST HEAD BEARINGS.

Slacken the head clip bolt by the nut (6, illus. 2A) and tighten the large fork stem locknut (4, illus. 2A).

When the adjustment is correct, retighten the head clip pin locknut (6 illus. 2A).

Check correct adjustment by turning the handlebars lock to lock to ensure there is no evidence of binding due to adjustment being set too close. Test for up and down lift, to ensure that all play has been taken up.

ADJUSTMENT OF FORK, LINK AND SPINDLE.

Girder Forks.

Whether it is a matter of routine adjustment or of re-assembly after dismantling correct link and spindle adjustment is most important and is carried out as follows. To adjust fork spindles, slacken the hexagon locknuts at each end of the spindle (8 and 9, illus. 2), and rotate the spindle by means of a spanner at the squared end (10) in an anti-clockwise direction to take up any side play being careful to do the operation on each shaft alternately, a little at a time. Probably one complete turn of the shaft will be all that is necessary.

If the forks are binding through too tight adjustment, the operation must, of course, be reversed.

Examine the fork shafts periodically and make sure that they are free in their respective bearings. Then tighten the locknuts (8, illus. 2), and if the adjustment is correct it should be just possible to rotate the knurled washers (11) situated on the left hand side next to the fork side links, conclude by tightening the nuts (9, illus. 2).

ROUTINE MAINTENANCE OF SHOCK ABSORBING UNITS. Telescopic Fork.

1. Keep exposed portion of inner telescopic member free from dirt.
2. Every 1,000 miles the units should be greased via the four grease nipples provided.
3. Every 5,000 miles the oil supply in the reservoir should be replenished.
See IA (ii) below for procedure.

FAULT FINDING AND RECTIFICATION.

I. Sticking or stiff operation of Telescopic Units.

- (a) If after a period of satisfactory service the struts appear to be sticking or are stiff in operation, one or all of the following actions should be taken:—

- (i) Lubricate bearings at points No. 21.
- (ii) Prop motor cycle removing weight from front wheel. Using "C" spanner ML57, remove dome nuts No. 11 affixed to top of each strut. With a rod check level of oil in the post No. 17. Level should be approximately $2\frac{1}{2}$ " from top of post.

- (iii) Remove dome nuts No. 11, illus. 11, release mudguard stay fixing bolts, allow top post No. 17 to protrude above inner strut No. 6. This will expose spring retainer No. 4. A piece of absorbent rag should be placed over the cavity between the inner and outer strut, to prevent oil running down the cavity during the next operation.

Remove retainer No. 4, this will allow the complete spring unit to be removed. Fill dome nut No. 11 with special fluid and pour into inner strut, repeat for other strut.

Replace spring unit and retainer No. 4, depress post No. 17 to full extent, when any excess oil will be pumped out of inner strut. During this operation check that movement is smooth. Prop motor cycle, removing weight from front wheel, remove rag with surplus oil and allow post to seat properly in top of outer strut. This may need tapping with a wooden mallet or something similar. See that dirt does not find its way into top post No. 17, refit dome nuts and mudguard stays.

- (iiii) To relieve any stress caused by incorrect assembly which may cause stiffness in operation, lower machine on to front wheel, slacken axle clamp nuts No. 10 on side opposite that carrying the brake drum, bounce machine heavily on front wheel, tighten axle clamp nuts.

Check operation of strut and if stiff in operation progressively operate it up and down about twelve times.

If, after the above procedure, the operation is unsatisfactory the units should be carefully examined as they may have become slightly bent as a result of some exceptional treatment. Should either of the components of the unit be bent, it must be straightened or replaced to ensure satisfactory service.

GENERAL DETAILS

2. Excessive Leakage of Grease from Lower Bearing.

A thin film of grease is permitted to pass the lower seals to facilitate removal of grit particles and this should be periodically removed. Should this become excessive the lower seals No. 23 should be replaced as they may have been damaged by hard and sharp road grit. To replace the seals it is advisable to remove the struts from the machine as complete stripping is necessary. After replacement of the seals a protecting sleeve must be fitted temporarily to facilitate insertion of the inner telescopic member as the threaded portion of the inner member would damage the feather edge of the seal.

The above work is best carried out at an authorised service station. It may be advisable, at the same time, to carry out a complete check, renewing such parts as are necessary.

3. Excessive Leakage of Oil from Lower Bearing.

If there is evidence of excess leakage of castor based oil from the lower bearing checks should be carried out as under IA (ii). If, after replenishing with oil, the oil is again lost via the lower bearing the rubber seals fitted in and under the top post should be replaced. Discharging, refilling and nut tensioning should be again carried out in accordance with IA (ii).

Note Relative to Special Fluids.

Only castor based fluids should be used for topping up reservoir as other fluids may cause damage to natural rubber springs. Examples of satisfactory fluids are :—

- (1) Lockheed Orange Brake Fluid.
- (2) Girling Brake Fluid.
- (3) Pure Castor Oil diluted with diacetone alcohol.

The bearing seals are of synthetic rubber and are not harmed by mineral based oils or greases.

TIRE SERVICE

HOW TO GET THE BEST OUT OF TIRES.

Probably more than 90 per cent of premature tire failures are due to causes which are within the control of the user.

Tires require some care, but, in total, the requirements are quite simple:—

First, last, and all the time, maintain in the tires the correct inflation pressure. Buy a pressure gauge and use it frequently. Do not guess at the pressure.

Avoid unnecessary or rapid acceleration and fierce braking—which wear out tires rapidly by causing wheel slip.

Drive at a reasonable speed, having regard to the road conditions, and do not “blind” over bad roads. The amount of concussion which the tires can stand is limited.

Do not allow flints, nails, etc., to remain embedded in the tread. They will work through, puncturing the tube and destroying the casing.

Keep oil, grease and kerosene away from the tires and from the spokes. If any finds its way on to the tires, remove it by using a clean cloth and a very little gasoline. Do not use too much gasoline, which may have a harmful effect on the rubber.

Should the front tire develop irregular or “stepped” wear interchange front and rear tires if practicable, or reverse the direction of rotation of the tyre in order to correct irregular wear, thereby restoring maximum resistance to tire slip.

THE TIRE VALVE.

The flow of air into the tire depresses the little spring-controlled plunger, thus opening a free passage.

The air cannot flow out of the tire because the return pressure closes the plunger on to its seat—and even if it should fail to do so the spring provides a positive action.

Thus the valve core embodies what is primarily a non-return valve to facilitate inflation and pressure checking, and forms a working seal. The valve cap provides a positive air seal and excludes dust and dirt. The valve, therefore, is not complete without a cap, which should be screwed down firmly by hand, not with tools.

If the valve core requires removing at any time for examination or renewal—first remove the valve cap, then insert the slotted end of the valve cap into the valve stem and unscrew by using it as a screw-driver.

PRESSURE GAUGE.

To check the pressure in the tire, the end of the pressure gauge is pressed on to the open end of the valve. It depresses the pin or plunger, and permits air to flow into the gauge and push up the calibrated piston showing “lb. per square inch.”

The determination of the correct pressure to use, and the testing to ascertain that it is put in at the time of inflating, is not quite the whole story.

What remains to be done now is to see that the pressure is always maintained.

Rubber is not absolutely impermeable to air, and the pressure may very slowly fall. Test, therefore, at frequent intervals (say at least once a week), and restore by a few pump strokes any air that has been lost. The use and maintenance of the correct pressure is the whole secret of successful tire use.

Do not spoil the tire and prevent it from doing its duty by depriving it of the only thing which makes it pneumatic.

TIRE FITTING AND REMOVAL.

Special Note.—Inextensible wires are incorporated in the beads of wired type tires. Therefore, do not attempt to stretch the wire beads of the tire cover over the rim flange.

Force is unnecessary and may be dangerous, as it merely tends to damage the cover beads and serves no helpful purpose.

Fitting or removing will be quite easy if the wire beads are carefully adjusted into the rim well: if it is found to be difficult, the operation is not being correctly performed.

The liberal use of water on beads and levers considerably eases the fitting and removal operations.

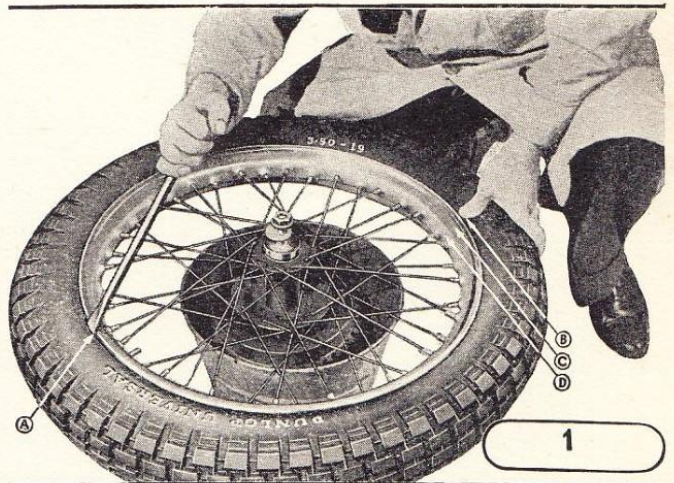

To Remove Tire.

Remove valve cap and core to deflate tire and place these parts where they will be free from dirt and grit.

Press each bead off its seat.

Insert a lever AT THE VALVE POSITION, and while pulling on this lever, press the bead into the well of the rim diametrically opposite the valve position. (Illus. 1).

Insert a second lever close to the first and prise the bead over the rim flange, holding the removed portion of the bead with the first lever.

TIRE SERVICE—contd.



Remove one lever and re-insert a little further away from the first lever (illus. 2). Continue round the bead, proceeding in small steps of 2-3", until bead is completely removed.

Remove tube from cover.

To Fit Tire.

Inflate tube just sufficiently to round it out without stretch. Too much air will make tire fitting difficult.

Too little will make tube more liable to be nipped by levers.

Fit tube in cover.

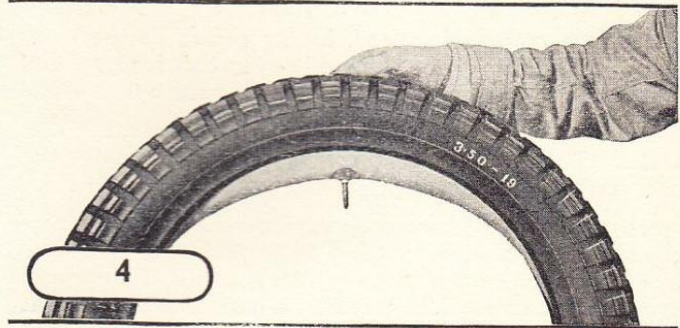

Pull tube slightly out of cover at valve position so that it protrudes about 1" beyond the beads for a length of about 9" (illus. 4).

Lay cover eccentrically over the wheel, the overhang being at the valve position and towards the operator.

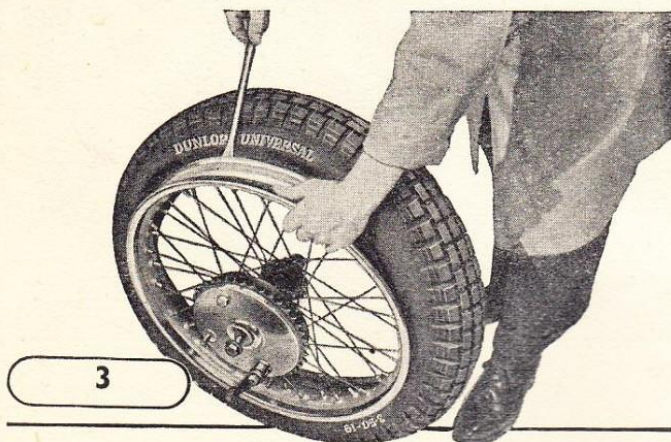

Stand wheel upright, and insert a lever between the remaining bead and the rim flange, and pull the cover back over the flange (illus. 3). If difficult to remove, maintain the pressure on the lever and tap the beads with a rubber mallet where they pass over the top of the flange.

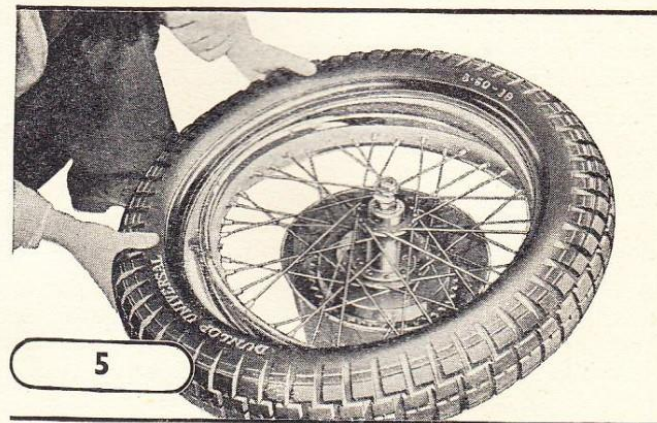

See that the valve is in line with the valve hole in the rim (illus. 5)

Squeeze beads together at valve position to prevent tube slipping back inside cover, and push cover towards rim, threading the valve through the valve holes in rim band and rim. Allow the lower bead to go into the well of the rim and the upper bead to lie above the level of the rim flange (illus. 5).

TIRE SERVICE—contd.

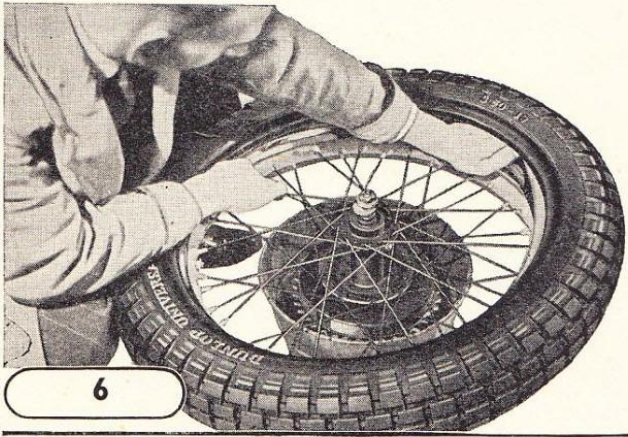

Working from the valve position, press lower bead over the rim flange by hand, moving forward in small steps, and making sure that the part of the bead already dealt with lies right down in well of rim—this is important. (illus. 6). If necessary use a tire lever for the last few inches (illus. 7).

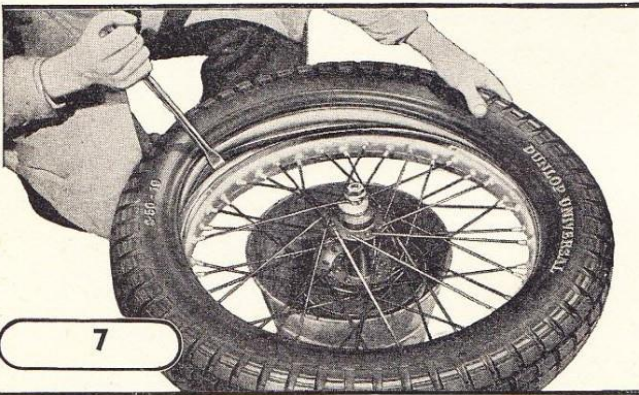

Press upper bead into the well of the rim diametrically opposite valve. Insert a lever as closely as possible to the point where the bead passes over the flange, and lever bead over flange.

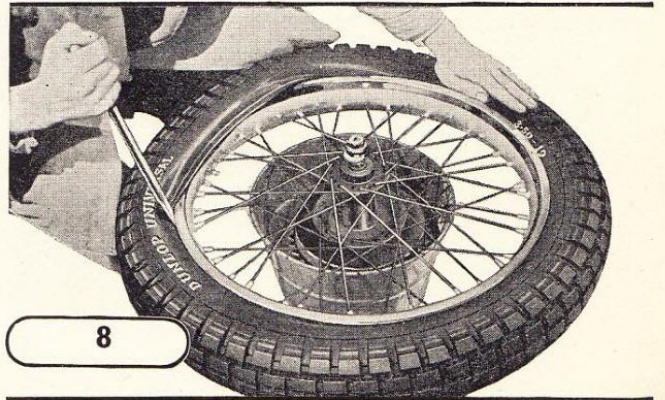

Repeat until bead is completely over flange, finishing at the valve position (illus. 8).

Push valve inwards to make sure that the tube adjacent to the valve is not trapped under the bead. Pull valve firmly back into position.

Inflate tire to required pressure.

Check that fitting line on the cover just above the bead is concentric with the top of the rim flange and that the valve protrudes squarely through the valve hole. Fit knurled rim nut and valve cap.

T O O L S

ML57

DOUBLE ENDED SPANNER TO SUIT EXHAUST PIPE NUTS, ALSO FRONT AND REAR WHEEL CONES.

ML55

DOUBLE ENDED SPANNER 3/16" AND 1/4" TO SUIT NUMBER PLATE PINS AND MUDGUARD STAY PINS.

ML56

DOUBLE ENDED SPANNER 5/16" AND 3/8" USED ON FOOT-REST HANGER, AND REAR MUDGUARD STAY PINS.

L1003

SINGLE ENDED SPANNER 7/16" FOR FOOT-REST ROD NUT, AND WHEEL SPINDLE NUTS.

VEI

SPARK PLUG SPANNER.

BML27A

MAGNETO POINT SPANNER, WITH FEELER GAUGE AND SCREWDRIVER FOR POINT ADJUSTMENT.

BML3DA

SCREWDRIVER.

BML61

RIVET EXTRACTOR.

ML59

SINGLE ENDED TIRE LEVERS (PAIR)

10D44

TOOL WALLET.

Villiers

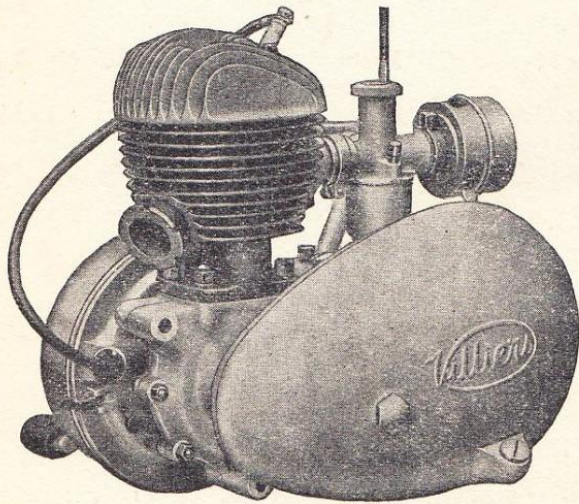

**MK. 10D.
UNIT**

**MK. 6E.
UNIT**

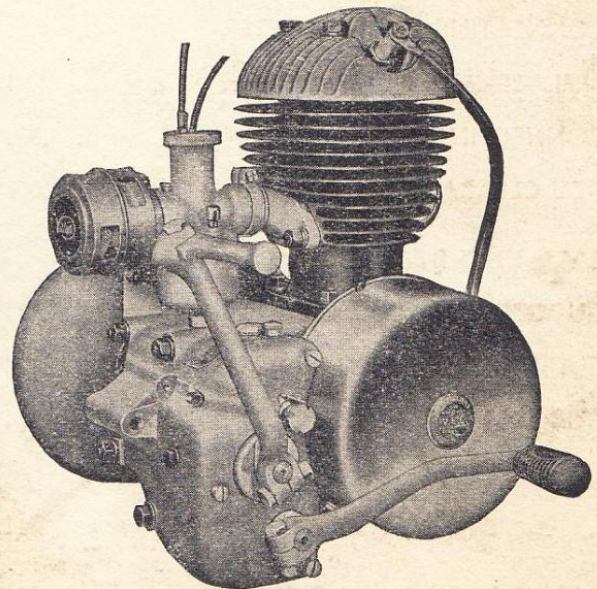

VILLIERS MK. 10D. & 6E. UNITS

TECHNICAL DATA

	Mark 10D.	Mark 6E.
CYLINDER BORE	50 mm.—1.9695"/1.9690"	59 mm.—2.3235"/2.3230"
STROKE	62 mm.—2.440"	72 mm.—2.834"
CUBIC CAPACITY	122 cc.—7.44 cu. ins.	197 cc.—11.70 cu. ins.
BALL BEARINGS.		
DRIVING SHAFT (L.H.)	20×47×14 mm. (2) 3 spot	20×47×14 mm. (2) 3 spot
DRIVING SHAFT (R.H.)	20×47×14 mm. (1) 3 spot	20×52×15 mm. (1) 3 spot
HIGH GEAR WHEEL	25×52×15 mm. (1) 3 spot	25×52×15 mm. (1) 3 spot
CLUTCH BALL RACE	50— $\frac{3}{16}$ " balls	50— $\frac{3}{16}$ " balls
KICK STARTER PEDAL	1— $\frac{1}{4}$ " ball	1— $\frac{1}{4}$ " ball
BIG END BEARINGS.		
CRANK PIN DIAMETER7170"/.7165"	.7983"/.7978"
REPLACEMENT SIZES7180"/.7175"	.7993"/.7988"
CRANK PIN ROLLERS (STEEL)	$\frac{1}{4}$ " dia. × $\frac{1}{4}$ " long	$\frac{1}{4}$ " dia. × $\frac{1}{4}$ " long
NUMBER OF ROLLERS (STEEL)	12	26
NUMBER OF ROLLERS (BRONZE)	6	None
CONNECTING ROD DIAMETER	1.2177"/1.2170"	1.2991"/1.2984"
REPLACEMENT SIZES	1.2187"/1.2180"	1.3001"/1.2994"
CONNECTING ROD WIDTH505"/.503"	.505"/.503"
SIDE CLEARANCE007"/.004"	.007"/.004"
SMALL END BEARINGS.		
GUDGEON PIN DIAMETER493"/.4925"	.493"/.4925"
GUDGEON PIN BUSH IN PISTON494"/.4932"	.494"/.4932"
GUDGEON PIN BUSH IN CON. ROD494"/.493"	.494"/.493"
PISTON RINGS.		
COMPRESSION RING (2 off)	1.969" × .0938"/.0928"	2.322" × .0938"/.0928"
GAP IN POSITION IN CYLINDER011"/.007"	.012"/.008"
MAXIMUM PERMISSIBLE GAP03"	.03"
RING CLEARANCE IN GROOVE (TOTAL)... ..	.006"/.004"	.006"/.004"
OVERSIZE PISTON RINGS	1.969" plus .015" and .030"	2.322" plus .015" and .030"

VILLIERS MK. 10D. & 6E. UNITS

TECHNICAL DATA—Contd.

SPROCKETS.	Mark 10D.	Mark 6E.
ENGINE	18 teeth for $\frac{3}{8}$ " pitch \times $\frac{1}{4}$ " roller \times .225" wide chain	19 teeth for $\frac{1}{2}$ " pitch \times .335" roller \times .205" wide chain
CLUTCH	51 teeth for $\frac{3}{8}$ " pitch \times $\frac{1}{4}$ " roller \times .225" wide chain	38 teeth for $\frac{1}{2}$ " pitch \times .335" roller \times .205" wide chain
GEARBOX	15 teeth to suit $\frac{1}{2}$ " pitch \times .335" roller \times .205" wide chain	15 teeth for $\frac{1}{2}$ " pitch \times .335" roller \times .205" wide chain
CHAINS.		
FRONT CHAIN	64 pitches, $\frac{3}{8}$ " pitch \times $\frac{1}{4}$ " roller, .225" wide. Endless (Renold 110038)	50 pitches, $\frac{1}{2}$ " pitch \times .335" roller, .205" wide. Endless (Renold 110044)
REAR CHAIN	$\frac{1}{2}$ " pitch \times .335" roller, .205" wide (Renold 110044)	$\frac{1}{2}$ " pitch \times .335" roller, .205" wide (Renold 110044)
CARBURETTER.		
"VILLIERS"	Type 3/4 single lever	Type 4/5 two lever
NOMINAL NEEDLE SETTING	Needle No. 3— $2\frac{13}{32}$ " out	Needle No. 4 $\frac{1}{2}$ —Variable
JET SIZE083"	.081"
IGNITION.		
CONTACT BREAKER GAP015"/.012"	.015"/.012"
POINTS COMMENCE TO OPEN	$\frac{5}{32}$ " before top of stroke	$\frac{5}{32}$ " before top of stroke
SPARKING PLUG	Lodge H.14 14 mm. short reach, or Champion J.10 Com. (U.S.A.)	Lodge HHN. 14 mm. short reach, or Lodge H.14 14 mm. short reach
SPARKING PLUG GAP018"	.018"
THREADS		
THREAD FOR SECURING GEARBOX SPROCKET	$\frac{7}{8}$ " \times 16 T.P.I. Whit. Form	
THREAD FOR SECURING FLYWHEEL	$\frac{9}{16}$ " \times 20 T.P.I. Whit. Form	
LUBRICATION.		
PETROL & OIL MIXTURE (PETROIL)	1 part SAE.30 oil to 16 parts of petrol (gasoline)	
GEARBOX	Fill through filler hole on top of gearbox body to height of level plug on back face of gearbox adjacent to rear fixing lug, with gear oil SAE.140. For cold conditions SAE.90 may be used, and for extremely cold conditions SAE.80 will be satisfactory	
CHAIN CASE	Fill to level of filler plug with the same oil as used for gearbox	

VILLIERS MK. 10D. & 6E. UNITS

OPERATION — MAINTENANCE

I THE ENGINE.

The Villiers Mk. 10D. and 6E. Units consist of separate engine and gearbox parts, bolted together to form one complete assembly. Most gearbox parts are common to both Mk. 10D. and Mk. 6E. except for the clutch chain wheel. The engine unit for the Mk. 10D. is a 122 c.c. air cooled two-stroke with bore of 50 mm. and stroke of 62 mm., and is fitted with a deflectorless type piston. The Mk. 6E. engine is similar but has a capacity of 197 c.c. with a bore of 59 mm. and stroke of 72 mm. Ignition is by the Villiers flywheel magneto which also provides current for lighting.

The Mk. 10D. engine is fitted with a Villiers single lever carburetter and a large combined air cleaner and strangler. The carburetter for the 6E. engine is of the two lever type having a variable needle to increase the mixture strength for starting. This is fitted with a large efficient air cleaner without strangler.

The gearbox provides three speeds, and has a totally enclosed kick starter mechanism and a positive gear change, operated by the right foot. The construction comprises a main and layshaft and one pair of sliding gears, and the gear wheels are always in mesh. The speeds or gears are selected by means of a patented ratchet mechanism making gear change positive. It is impossible for a gear to be missed, the foot gear control pedal returning to a normal position after each operation in readiness for the next change. The pedal is lifted by the toe to change to lower speeds, and pressed downwards to obtain a higher speed. The gearbox is fitted with an efficient two-plate cork insert clutch disengaged by means of a lever on the gearbox through a Bowden cable and a lever on the handle bar. Reference to Fig. 5 will show how the various gears and shafts are fitted, and how the three speeds are obtained by moving the sliding wheels into their positions along the shafts.

2 OPERATION OF THE TWO STROKE ENGINE.

In the cylinder walls are arranged four holes or ports, viz., one exhaust port through which the burned charge is allowed to escape, two symmetrical transfer ports which, through passages on the side of the cylinder, are in communication with the crankcase, and one inlet port which permits the air-fuel mixture to enter the crankcase. Movement of the piston in a vertical direction is arranged to cover and uncover the ports at suitable times so that the mixture is first drawn from the carburetter through the inlet port into the crankcase. There it is compressed and then forced through the transfer passage into the cylinder above the piston, where it is further compressed. It is then ignited by a spark from the plug, and after expansion due to heat, escapes through the exhaust port, to the silencer.

The cycle of operation is as follows :

(a) Upward Stroke of Piston.

Crankcase. The exhaust and transfer ports are first covered by the movement of the piston, thus sealing the crankcase from the cylinder. Further movement reduces the pressure in the crankcase below that of the atmosphere, and when the inlet port is uncovered by the piston at the top of this stroke, a mixture of fuel and air enters the crankcase.

(b) Downward Stroke of Piston.

Crankcase. The piston movement closes the inlet port, and consequently, the charge in the crankcase is compressed until near the bottom of the stroke the transfer port is uncovered by the piston top passing the port. This allows the mixture to enter the cylinder through the transfer passages which are arranged in such a direction that the incoming charge is forced to the side of the cylinder remote from the exhaust port and at an angle which causes it to be deflected towards the cylinder head where it reverses its direction and drives out the remaining exhaust gas through the exhaust port.

Cylinder. After the closing of these ports a charge above the piston which enters during a downward stroke will be compressed and then ignited by the sparking plug when the piston is near to the top of the stroke.

Cylinder. The temperature of combustion causes a very high pressure above the piston, forcing it to descend. Near the end of this stroke the piston uncovers the exhaust port and the remaining pressure causes the burnt charge to escape rapidly through the port into the silencer. Shortly after the exhaust port is opened the transfer port is uncovered allowing the compressed charge in the crankcase to enter the cylinder above the piston.

From the above description it will be seen that an upward stroke of the piston causes a charge to enter the crankcase, and compresses a previous charge in the cylinder head. On the downward stroke the charge in the crankcase is being compressed while the ignited charge in the cylinder is expanding.

3 MAINTENANCE OF ENGINE POWER.

The performance of the engine largely depends on the fit of the piston and rings in the cylinder bore, the disposition and area of ports, the gas tightness of crankcase and cylinder head. To obtain maximum power it is, therefore, necessary to keep all ports free from excessive carbon deposits, and maintain good compression in the cylinder and in the crankcase by attention to all cylinder head and crankcase joints.

VILLIERS MK. 10D. & 6E. UNITS

LUBRICATION — RUNNING-IN — PERIODICAL ATTENTION

4 LUBRICATION OF ENGINE.

In order to maintain the efficiency of the engine and gearbox and to reduce wear to a minimum it is essential that all moving parts are adequately lubricated. The system adopted with these engines is known as the Petroil system, in which the correct quantity of oil is first mixed with petrol (gasoline) before pouring into the tank. As the mixture first enters the crankcase and then into the cylinder, all working parts are adequately lubricated, and as the amount of fuel used will increase with the power output, it will be seen that under arduous conditions a greater quantity of oil will automatically be supplied. The correct proportions are $\frac{1}{2}$ pint of oil SAE.30 to one gallon of petrol. Make sure that it is well mixed before putting into the tank, otherwise undiluted oil is likely to get into the carburetter and cause considerable trouble through choking the passages.

We recommend the use of Wakefields Castrol XL oil for these engines, but in parts of the world where this is not obtainable, Shell X 100, SAE.30, Double Shell, or Mobiloil A may be substituted.

For the gearbox and chain case SAE.140 oil or other high grade gear oil should be poured through the filler plug hole up to the level of the filler plug in the chain case and to the level of a small plug at the back of the gear box. Oil should not be allowed to fall below the level of the bottom of the dip stick which is to be found near the filler plug of the gearbox. SAE.90 oil should be used for cold conditions or SAE.80 for extremely cold climates.

5 RUNNING IN.

The useful life of a motorcycle engine depends to a great extent on how it is driven during the first 500 miles, and during this period the machine should not be driven at more than 30 m.p.h. in top gear, 20 m.p.h. in middle and 8 in bottom gear. Do not allow the engine to labour in top gear, change to lower gear and slightly close the throttle to prevent the engine racing.

6 PERIODICAL ATTENTION.

It is advisable in order to enjoy trouble-free riding that the engine and machine should have periodical attention. The following hints will help to keep the engine and machine in good running order.

Daily check level of petroil mixture in tank and fill up if necessary.

Every 1,000 miles examine the level of the oil in the gearbox and chain case. Top up if necessary.

Every 5,000 miles drain gearbox by removing the drain plug in the bottom of the box and refill with fresh oil.

The chain case can be drained by removing the front cover, as no drain plug is provided. It is advisable to do this when the engine is warm, as the oil will drain away more quickly. Fill up with new oil of the appropriate grade.

Examine the contact breaker points after the first 500 miles have been completed, as the points may require slight adjustment after initial bedding in. The correct gap when the points are fully open is .015". They should be kept free from oil.

Every 2,000 miles remove the cylinder head and scrape out carbon. The edges of the exhaust port in the cylinder can be cleaned when the piston is at the bottom stroke. Clean piston top. It should not be necessary to remove the barrel and piston, every 4,000 miles should be sufficient.

Every 2,000 miles remove and clean silencer and exhaust pipe.

Every 5,000 miles remove and wash out air cleaner with gasoline. Leave to dry. Dip into thin oil and leave to drain before replacing. More frequent cleaning will be necessary under dusty conditions.

Clean spark plug points and set to gap .020"—do not overtighten when re-fitting plug.

Occasionally check clutch and clutch cable adjustment. Adjust the knurled knob above the kick starter boss until definite freedom is felt at the end of the lever projecting out of the dust cover. If this freedom is excessive the clutch will not free properly. If there is appreciable slackness in the clutch cable, this can be taken up by means of the cable adjuster on the gearbox cover. A slight trace of slack should be felt in the cable, otherwise the clutch may be slightly disengaged and cause slipping.

Tighten the locknut on the cable adjuster after adjusting the cable. Occasionally examine joints, cylinder head, cylinder base, crankcase, gearbox and chain case for gas or oil leaks and tighten if necessary.

Examine all possible nuts, bolts and screws for tightness.

7 STARTING THE ENGINE—MK. 10D. UNIT.

See that the gear is in neutral or free engine. This position can be obtained by lifting the gear control pedal until bottom gear is engaged, then press down the pedal approximately half the normal travel when the neutral will be found. It should then be possible to rotate the back wheel without revolving the engine. Turn the fuel tap to the "ON" position, and when the engine is COLD depress the tickler on the carburetter until fuel appears, showing that the float chamber is full. Close the strangler in the air cleaner, open the throttle approximately one third of the total movement of the throttle lever or twist grip and depress the kick starter once or twice to draw an initial charge of mixture into the engine. Then give a sharp kick downwards, when the engine should start. Open the strangler fully as soon as the engine is sufficiently warm to run with it in the open position. The engine should not be run on the road with the strangler closed, as this may cause oiling up of the sparking plug, lack of power and waste of fuel. When the engine is hot do **not** flood the carburetter or close the strangler.

VILLIERS MK. 10D. & 6E. UNITS

STARTING — DRIVING HINTS — DECARBONISING

8 STARTING WITH THE 6E. UNIT.

Starting with this engine is similar to the above except that no strangler is fitted to the air cleaner, but the necessary mixture enrichment for starting from cold is obtained by moving the mixture control lever on the handlebar to the position marked "RICH." After the engine has started the lever should be returned to the normal operating position.

If the engine fails to start it is probably due to too rich a mixture. Depress kick starter several times with the throttle wide open to clear the engine of excess fuel. Close the throttle to normal position and try again.

If further attempts fail to start the engine, take out the sparking plug and examine the points. If they are wet with fuel and oil, clean the points and dry or use another plug. Test ignition by holding plug body on cylinder head fins with the sparking plug wire attached to the plug, and depress kick starter. Take care not to touch the high tension terminal when testing the plug, as the result may be unpleasant. If a good spark is obtained, replace the plug in the cylinder head and try again. If no spark is obtained, see that the contact breaker points are clean and set to the correct gap.

Difficulty in starting is sometimes caused by slight flooding of the carburetter when the machine is standing. This allows neat fuel to enter the crankcase resulting in a rich mixture. It is wise, therefore, to close the fuel tap if the machine is being left for any length of time, but the difficulty in starting due to this cause can usually be overcome by using a wide throttle opening, but it may in some cases be necessary to drain the crankcase by removing the drain plug (No. 28, Fig. 4). Do not forget to replace the drain plug, as this omission will certainly cause difficulty in starting.

Further information as to the possible causes of difficulty in starting is shown in the charts given later in this book.

9 DECARBONISING.

In order to maintain engine efficiency it is advisable about every 2,000 miles to remove all carbon deposit from inside the cylinder head, the top of the piston and the edges of the ports. The exhaust pipe and silencer and fish tail or pipe should also be cleaned out.

10 TO REMOVE CYLINDER HEAD.

Disconnect the sparking plug wire from the sparking plug and remove the sparking plug from cylinder head. Unscrew the four cylinder head fixing bolts; the head can now be lifted off. With a soft copper scraper remove all carbon deposit from the inside of the head, taking care not to damage the joint face, as a leak may be caused. With the piston at the top of the stroke remove all carbon from the piston top. Wipe off any loose carbon from around the edge of the piston, then unscrew the exhaust pipe nut and remove silencer and exhaust pipe.

Move the piston to the bottom of its stroke, and scrape out any carbon from exhaust stub and from the edges of the port in the cylinder bore; this is best done from the outside of the cylinder, taking great care to avoid scratching the cylinder bore. A piece of soft cloth placed in cylinder bore will help to prevent the scraper causing damage and also prevent any particles of loose carbon from falling down through transfer passages. Make sure there is no loose carbon about before assembling. Remove any accumulation of mud or grit from the fins.

11 TO REPLACE CYLINDER HEAD.

No gasket is fitted between cylinder head and barrel; these joint faces must be perfectly clean and flat, and free from scratches or bruises. Place head in position, the sparking plug being at the rear (10D), and on magneto side (6E). Each cylinder head bolt should have a thick plain steel washer under its head. Screw down each bolt finger tight; finally screw down each bolt half a turn at a time until all are fully tight. Clean and re-adjust plug points if necessary and replace plug. Replace high tension lead, silencer and exhaust pipe.

12 TO REMOVE CYLINDER BARREL.

Remove cylinder head (see para. 10), remove carburetter by undoing square headed screw fitted to carburetter clip. Disconnect the fuel pipe from the carburetter and tank. The carburetter can either be left attached to its cables or it can be removed by unscrewing the top ring nut, and removing the throttle slide (No. 17, Fig. 27) complete with needle. Care should be taken to see that the throttle slide and needle are not left in such a position that they can be damaged. Unscrew exhaust pipe ring nut (No. 5, Fig. 4) using special spanner. Remove cylinder base nuts and washers. Rotate crankshaft until piston is at bottom of stroke. Raise cylinder until clear of piston, but do not twist cylinder, otherwise the ends of piston rings may come in contact with the edges of the ports which may cause rings to fracture. Cover the opening into crankcase with a piece of clean rag.

13 TO REMOVE PISTON.

Remove one of the two gudgeon pin circlips (No. 18, Fig. 4) using special round nosed circlip pliers, Fig. 2. Push gudgeon pin (No. 17, Fig. 4) out of piston. If carbon deposits prevent removal by hand the use of an extractor of the band type is recommended, or special tool S.T.264/5 (Fig. 3), although it may be effected by tapping gently with a hammer. In that case be sure to support the piston to avoid any strain being placed upon the connecting rod.

Lift piston away, and mark the inside of the skirt to enable it to be refitted in the same position relative to the cylinder.

Note. The gudgeon pin is a sliding fit in the piston and connecting rod small end bush.

VILLIERS MK. 10D. & 6E. UNITS

DECARBONISING — REBORING — HONING

The piston rings may be removed without risk of damage by introducing behind the ring three pieces of thin brass strip spaced (see Fig. 1) and then sliding off the rings. Do not scratch the piston. It is desirable to ensure that each ring is refitted in its original groove.

Before refitting the cylinder the bore should be checked for wear by means of a dial gauge. If the wear exceeds .008" the cylinder should be rebored to the next oversize. Even if the wear is not serious, but there are scars or scratches, reboring will be necessary. The pistons should also be checked for wear. The standard sizes of pistons available are :

- (1) Standard diameter.
- (2) .015" oversize.
- (3) .030" oversize.

14 RE-BORING OF CYLINDER.

When it has been established that re-boring is necessary and the size of bore to which it will be finished has been decided, *i.e.*, .015" or .030" oversize, the following method should be adopted :

Choice of Machine.

This may be any precision fine boring machine such as Heald 48A Borematic or Excello type 309, or alternatively any boring bar of repute, such as Van Norman, etc.

Choice of Tool.

This should preferably be tipped with tungsten carbide equivalent to the Wimit Grade "N."

Location.

This is done off the spigot at the base of the cylinder, which should be clamped against an angle bracket by two clamps bearing on the cylinder head joint face.

Boring

When it has been determined that the location of the cylinder is perfectly concentric to the boring bar (this is checked by the revolving boring bar into the cylinder leaving a witness mark on the whole of the circumference) a preliminary cut of .010" is taken over the full length of the cylinder. The recommended feed for this cut is from between .003" and .005" per rev. This is followed up in the case of the .015" oversize cylinder by a finish cut of approx. .004" to .0045" on diameter with a feed of .0002" per rev., thus leaving from .0005" to .001" for honing. In the case of the .030" oversize bore a preliminary cut of .015" with a .005" feed per rev. is taken. This is followed on by a second cut of .010" with the same feed and finished

by a last cut of from .004" to .0045" with a .0002" feed per rev. for finishing.

15 HONING.

Choice of Machine.

The machine may be any of the vertical or horizontal reciprocating type honing machine. In the latter type fixed hones should be used, but preference is given to the vertical machine where a floating hone may be employed.

Grade of Stone.

This should be 320M or its equivalent. This grade is made by the Universal Grinding Co., and is a general purpose stone.

Coolent.

This is very important and good quality paraffin (kerosene) mixed with up to 25% lard oil should be used. Care should be taken firstly that a liberal flow of coolent is directed well in the cylinder bore, secondly that an adequate filter is installed in the coolent circuit to separate the particles of abrasive. As a guidance, the finish to be obtained from honing should be from 5 to 10 micro. inches. In the absence of suitable equipment for measuring the surface finish we recommend that a comparison

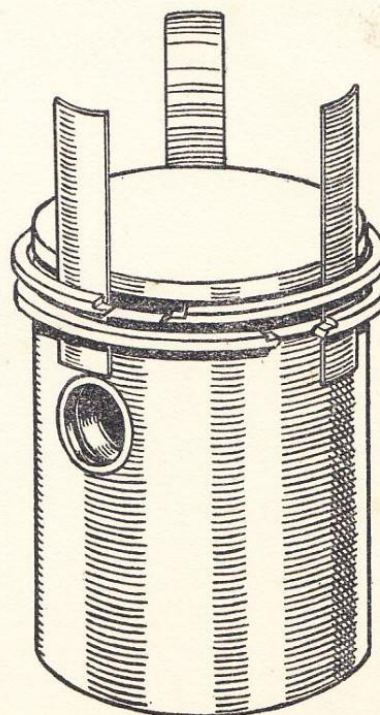

FIG. 1.

VILLIERS MK. 10D. & 6E. UNITS

RE-FITTING PISTON — CYLINDER & CYLINDER HEAD

HONING—Contd.

check is taken with either a new cylinder or a test block which has the required surface finish.

16 GAUGING.

Mk. 10D. (a) .015" oversize should be 1.9845"/1.9840"
 Mk. 10D. (b) .030" oversize should be 1.9995"/1.9990"
 Mk. 6E. (a) .015" oversize should be 2.3385"/2.3380"
 Mk. 6E. (b) .030" oversize should be 2.3535"/2.3530"

17 TO RE-FIT CYLINDER AND PISTON.

When fitting a new piston remember to fit two circlips, one on each side of the gudgeon pin.

All parts must be clean. Before replacing rings on piston they should be checked for wear by inserting each ring into the least worn parts of the cylinder barrel, *i.e.*, at the bottom, and checking width of ring gap with a feeler gauge. The ring must be placed so that it lies square in the bore to obtain a correct reading.

If gap measures .030" or more, fit new rings to give a minimum gap of .007". The maximum gap permissible for new rings is .011".

Place rings on piston using three pieces of thin brass (see illus. Fig. 1), radial location being made by the pegs fitted in the grooves. Place piston over connecting rod, ensuring that it is in the correct position as originally fitted, that is, with the same rubbing faces together.

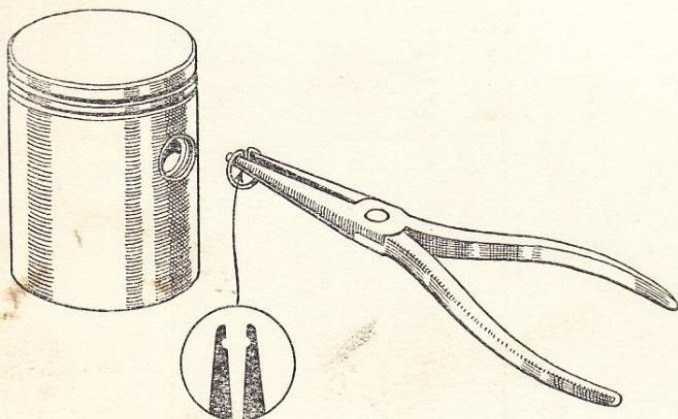

FIG. 2.

Smear gudgeon pin with engine oil and fit it into piston, and pass it through the connecting rod small end bush until it butts against the circlip which was left in the piston. Re-fit the other circlip and make quite sure that each circlip lies snugly in its groove. **This is essential.**

Note. Circlips bent or damaged in any way should be discarded and new circlips fitted. Remove rag from crankcase opening. It is essential to make a gas tight joint, so therefore, the joint faces must be clean and undamaged.

Fit new cylinder base washer to crankcase (No. 16, Fig. 4). No jointing solution should be used. Smear cylinder bore and piston surfaces with engine oil and fit cylinder barrel over piston taking every care not to twist the cylinder which would cause the ring ends to foul ports. Ensure each piston ring is fully compressed in its groove with the ends correctly fitting on the pegs in turn, as the barrel passes over it. Replace cylinder barrel holding nuts and washers, screwing each in turn until all are fully tight.

18 TO REPLACE CYLINDER HEAD.

No gasket is fitted between the cylinder head and the barrel, but the faces should be perfectly clean and flat. Place the head in position, the sparking plug being at the rear on the Mk. 10D. engine and on the right-hand side on the Mk. 6E. engine. Each cylinder head bolt (No. 1, Fig. 4) should have a plain steel washer (No. 2, Fig. 4) under the head. Engage each bolt finger tight. Finally screw down each bolt in turn until all are fully tight.

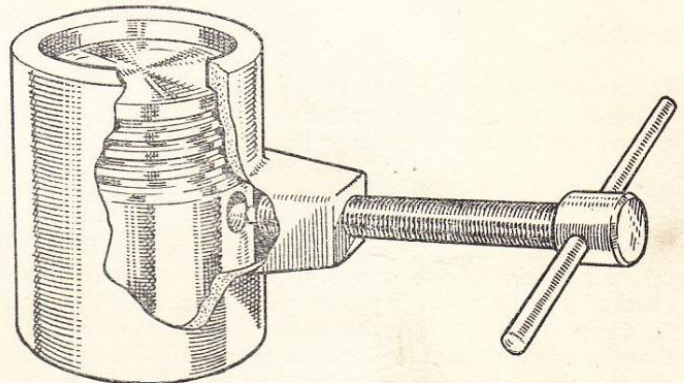

ST.264-10D
 ST.265-6E

FIG. 3.

VILLIERS MK. 10D. & 6E. UNITS

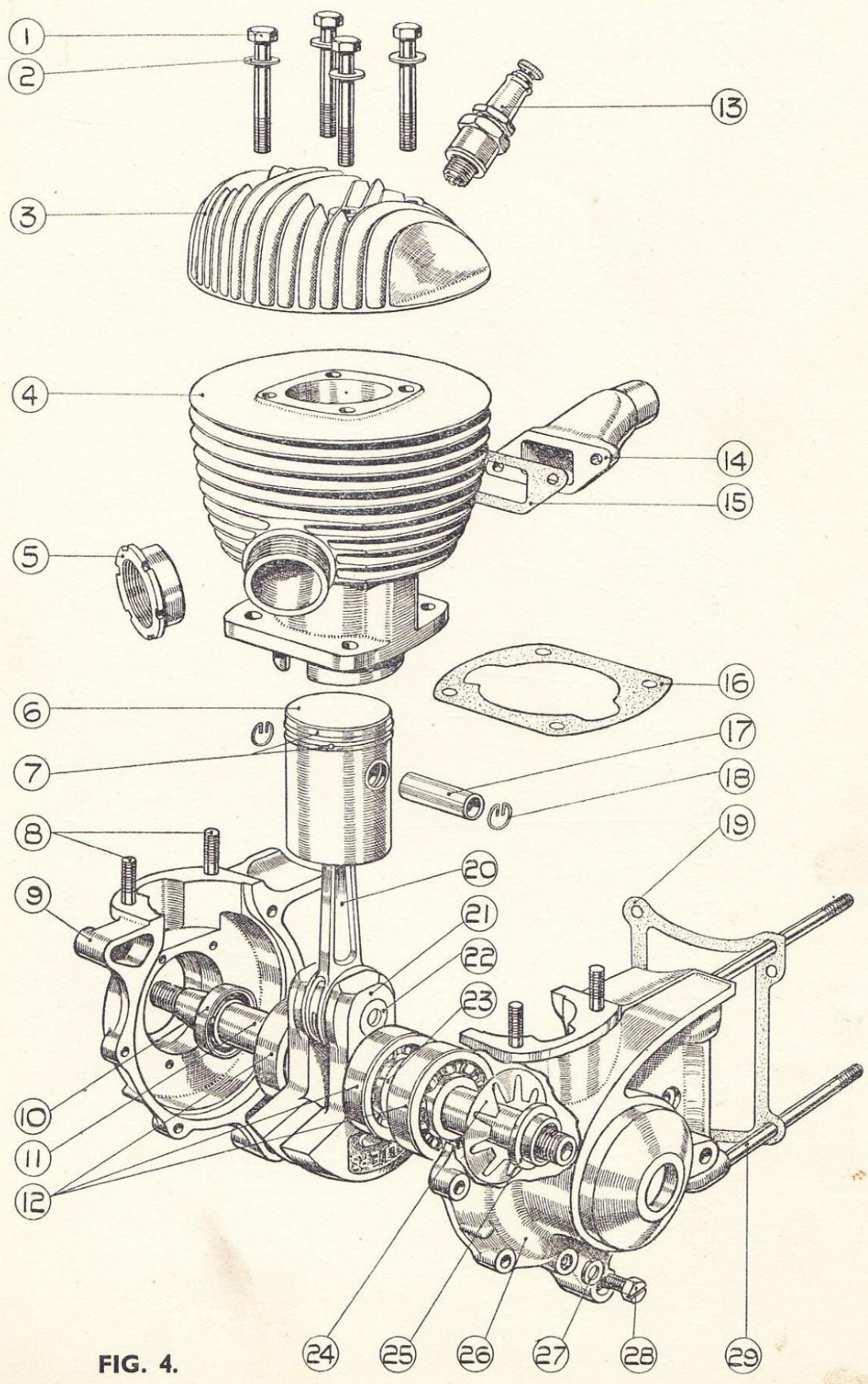

FIG. 4.

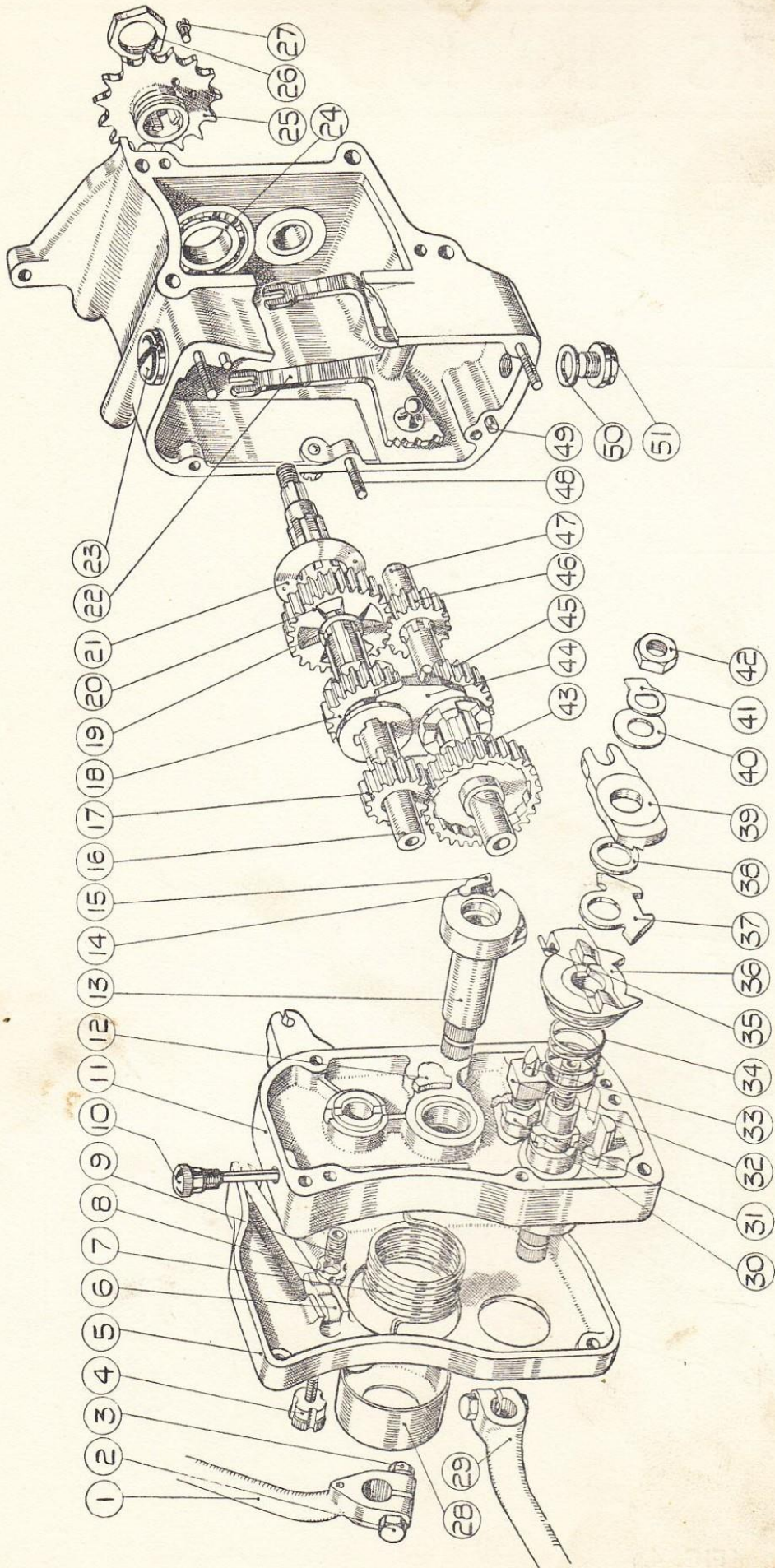

FIG. 5.

VILLIERS MK. 10D. & 6E. UNITS

REMOVING UNIT FROM FRAME — DISMANTLING UNIT

19 TO REMOVE POWER UNIT FROM FRAME.

Remove exhaust pipe ring nut (No. 5, Fig. 4) securing the exhaust pipe with special spanner. Remove copper asbestos washer. Detach petrol pipe by unscrewing union nut at the tank end or the banjo bolt at the carburetter end. Release square headed bolt (No. 20, Fig. 28) which secures the carburetter to the inlet pipe and remove carburetter complete. Disconnect the cable nipple from the clutch operating lever on the gearbox dust cover and unscrew cable adjuster from the lug on the gearbox end cover. Tie up the cable out of the way. Disconnect the lighting cables at the connectors. Undo the front attachment of the rear chain guard. Remove nuts and washers from the three main engine bolts and support the engine while the bolts are removed. It should then be possible to lift the engine out of the frame. It is not possible to give exact instructions for removing the power unit, as this will depend upon the individual machine, and it may be necessary

to proceed in a slightly different manner according to the design of the other parts of the machine.

20 TO DISMANTLE ENGINE AND GEARBOX UNIT.

Having removed the engine from the frame (see para. 19) mount on a dismantling jig S.T.244 such as is shown in Fig. 6. Remove aluminium cover from magneto by springing aside three retaining clips.

Remove :

The magneto, flywheel and armature plate. The flywheel by unscrewing centre nut anti-clockwise, preferably using the special hammer-tight spanner obtainable from Service Agents. The nut is imprisoned and acts as an extractor.

Detach the sparking plug lead from the plug and remove the armature plate from the crankcase by unscrewing the four countersunk headed screws near to the centre boss of the armature plate. When drawing the armature plate away from the engine do not allow the bore to come into contact with the threaded end of the shaft, otherwise it is possible to damage the delicate edge of the rubber oil seal fitted to the armature plate. Any cut on the sealing lip will permit oil to leak along the shaft and perhaps reach the contact breaker points.

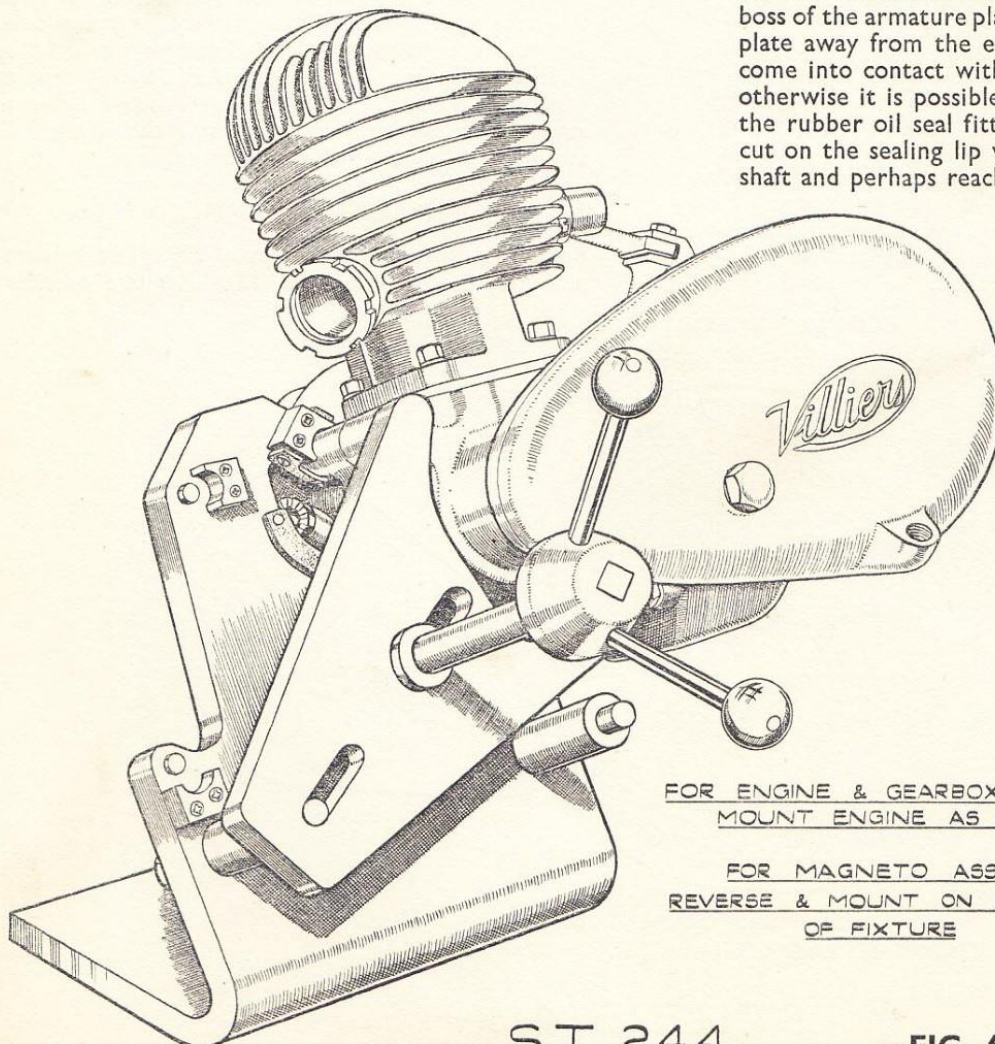

FOR ENGINE & GEARBOX ASSEMBLY
MOUNT ENGINE AS SHOWN

FOR MAGNETO ASSEMBLY
REVERSE & MOUNT ON L.H. SIDE
OF FIXTURE

S.T. 244

FIG. 6.

VILLIERS MK. 10D. & 6E. UNITS

DISMANTLING UNIT

DISMANTLING—Contd.

If it is only intended to dismantle the gearbox, the magneto should not be removed, and the above instructions can be disregarded.

21 TO DISMANTLE PRIMARY CHAIN CASE.

With the engine in an upright position undo the centre nut securing the outer half of the primary chain case. Place a tray to catch the oil from the chain case when the cover is removed. Allow oil to drain away, wash out chain case and clutch, etc., with petrol (gasoline). Take off the chain case joint washer carefully and put away safely in readiness for replacement. Next dismantle the clutch by removing the six round headed screws (No. 1, Fig. 13) securing the clutch springs. Take off the outer plate (No. 3, Fig. 13), the cork tanged plate (No. 4, Fig. 13) and plain centre plate (No. 6, Fig. 13) noting the order in which these parts were fitted. Unscrew the engine sprocket nut (No. 9, Fig. 13) using the special service locking plate (S.T.123) Mk. 6E, or (S.T.124) Mk. 10D, as shown on Fig. 7, to prevent the sprocket turning. Remove spring washer. It will now be possible to withdraw the engine sprocket, using extractor (S.K.1793, Fig. 8). The chain and clutch chain wheel will come away at the same time. There may be packing shims at the back of the engine sprocket boss for adjusting the primary chain line, if so, remove carefully and do not lose them. The engine should now be tilted on to its left-hand side and the two lengths of clutch operating rod removed from the bore of the gearbox main shaft.

22 TO REMOVE INNER-HALF CHAIN CASE.

Return the engine to the upright position and unscrew the nut (No. 12, Fig. 13) which holds the clutch centre to the gearbox main shaft. The use of the service locking plate (S.T.122, Fig. 7) will prevent the centre from turning while the nut is removed. Take off the spring washer and slide the clutch centre from the splined shaft. It will now be possible to remove the inner half chain case. Remove the locking plate screw, and the locking plate, which will be found below the gearbox shaft on the inside of the inner half case. Remove the nut and also the small nut securing the rear chain guard attachment. The inner half of the chain case can now be withdrawn. Take care not to damage the joint washers fitted between the chain case and the crank case; they will be needed when re-assembling.

23 GEARBOX REMOVAL.

The engine and gearbox can now be separated by removing the nuts on the back of the gearbox body and one from between the gearbox and the bottom engine fixing lug. Slide the gearbox off the long studs taking care not to damage the joint washer which is fitted between the engine and the gearbox. Remove this washer before attempting to dismantle the engine.

24 TO DISMANTLE ENGINE.

Remove cylinder head (see para. 10) cylinder barrel (see para. 12) piston (see para. 13). Remove cylinder base

FOR 10-D ENGINE
USE SERVICE TOOL ST.124

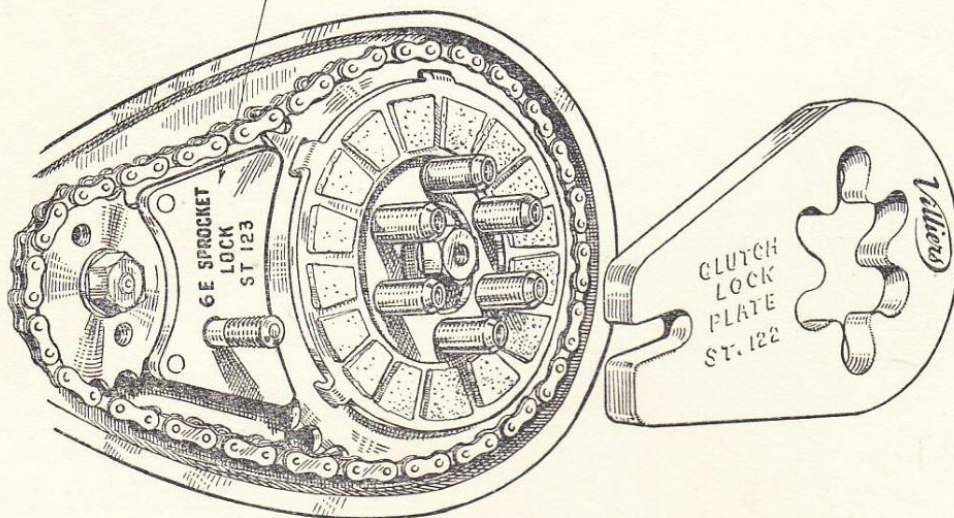

WHEN USING THESE TOOLS
ENGINE SHOULD BE MOUNTED ON STAND ST244

ST.122/3/4

FIG. 7.

VILLIERS MK. 10D. & 6E. UNITS

DISMANTLING UNIT

washer. The two halves of the crankcase can now be separated by removing the three long and two short crankcase studs which clamp the two halves of the case together. The magneto side of the case should be removed from the shaft by means of an extractor (S.T.120) as shown in Fig. 9, the drive side by extractor S.T. 121 (10D.) S.T.242 (6E.), Fig. 10. The ball bearings may remain in the cases. If this is so, they may be removed if necessary by means of an expanding extractor S.T.266 (Fig. 12). Alternatively the cases may be heated up by dipping in boiling water when the bearings may be pushed out easily. Take out the gland spring and gland from the left-hand case. If the bearings, however, remain on the shafts, and if it is necessary to remove them for replacement or for dismantling the crankpin and connecting rod, they can be removed by means of an extractor as shown in Fig. 11. (S.T.268).

25 TO DISMANTLE ENGINE AND GEARBOX UNIT.

Remove unit from the frame (see para. 19) and mount on dismantling jig, such as is shown in Fig. 6.

Remove :

Aluminium cover from magneto.

The magneto flywheel and armature plate.

The flywheel by unscrewing centre nut anti-clockwise, preferably using the special "hammertight" spanner obtainable from Service Agents. The nut is imprisoned

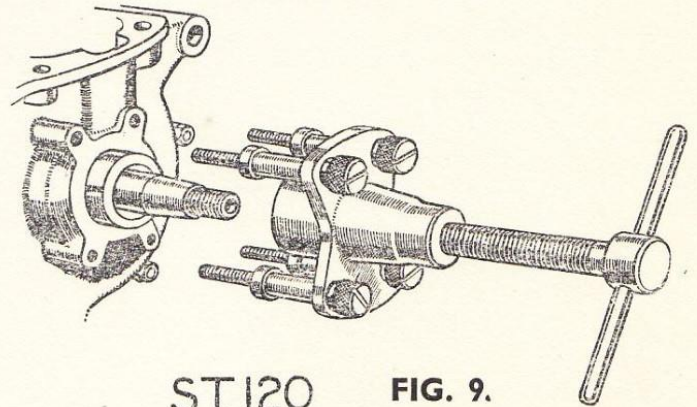

ST.120 FIG. 9.

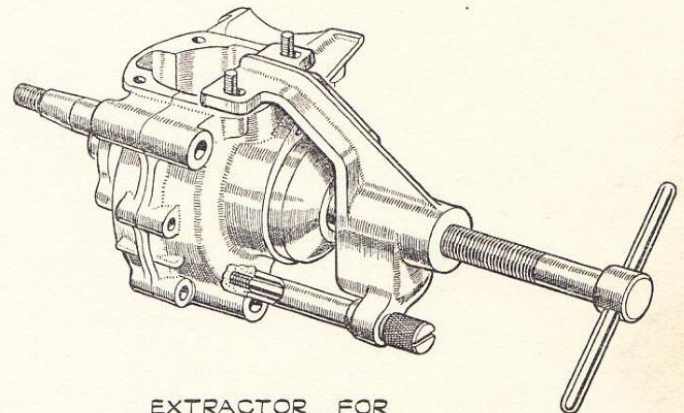

EXTRACTOR FOR
LEFT HAND CRANKCASE HALF
FOR 10-D ENGINE ST.121
FOR 6-E ENGINE ST.242

FIG. 10.

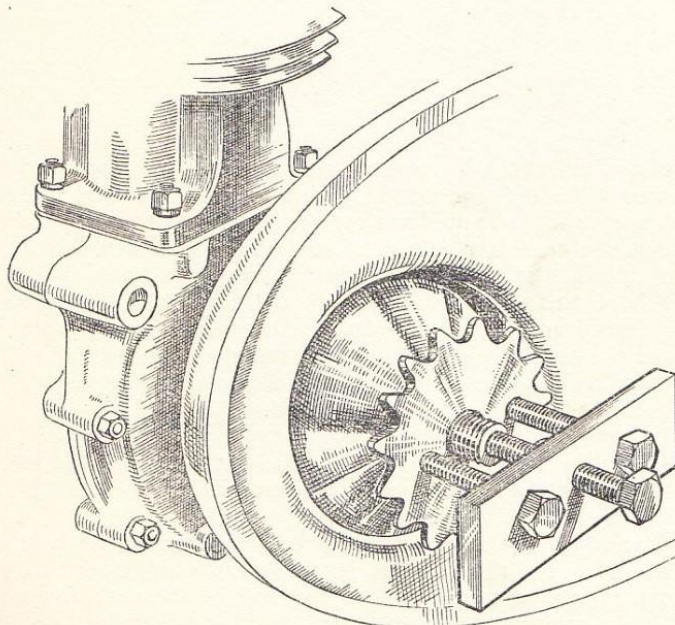

SK.1793

FIG. 8.

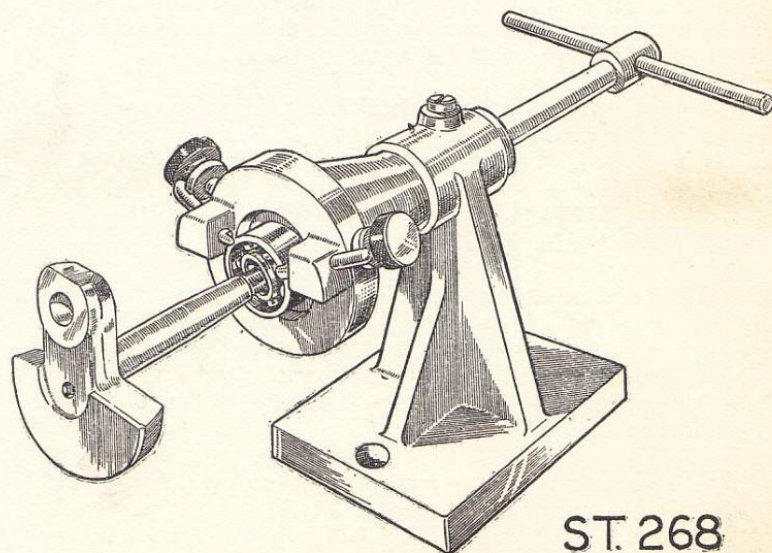

ST.268

FIG. 11.

VILLIERS MK. 10D. & 6E. UNITS

DISMANTLING UNIT

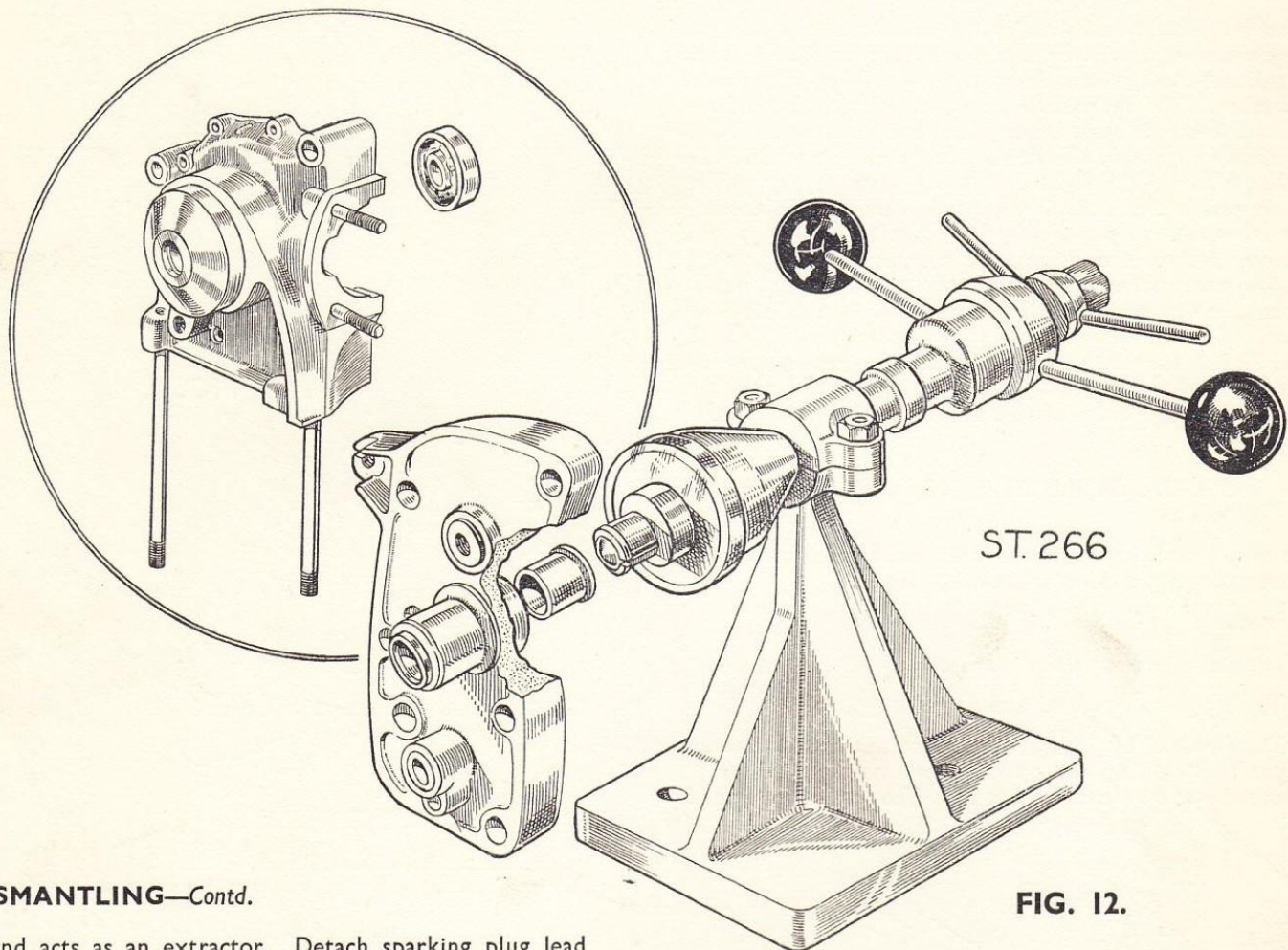

DISMANTLING—Contd.

and acts as an extractor. Detach sparking plug lead and remove the armature plate from the crankcase by unscrewing four countersunk headed screws found on the centre boss of the armature plate.

If it is only intended to dismantle the gearbox, the magneto should **not** be removed and the above instructions disregarded.

26 DISMANTLING AND RE-ASSEMBLING DRIVING SHAFT ASSEMBLY.

The removal of the crankpin requires a special fixture, (S.T.116) Fig. 14, in which the shafts are held whilst the crankpin is removed. The side float of the big end is allowed for when building. Do not mistake this float for up and down play; a small amount of "rock" is of no importance.

The re-assembly of the crankshaft and connecting rod can only be carried out properly by the use of a special fixture S.T.273 (6E), S.T.274 (10D), Fig. 15, and truing fixtures, and quite a lot of experience is necessary before a really satisfactory result can be obtained. In the event

of a failure of the big end, we recommend that a complete crankshaft and connecting rod assembly, made in the factory, should be used as a replacement. This will ensure that the necessary degree of accuracy of this assembly is obtained, and that the correct parts have been used. Where this is impossible it should be noted that the required amount of interference between the crankpin and the hole in the crankshaft can only be obtained by the use of an oversize crankpin, which also makes it necessary to use an oversize connecting rod.

The following is a description of the methods used in the factory for the assembly of these components.

One end of the crankpin is pressed into the crankpin hole of one of the shafts, being guided in such a manner that the pin is kept square with the face of the crankshaft. When replacements are necessary the crankpin is made .001" larger than the standard size as previously mentioned. The crankpin is of course, assembled from the inside face of the driving shaft to prevent the possibility of the roller track being damaged through passing through

FIG. 12.

VILLIERS MK. 10D. & 6E. UNITS

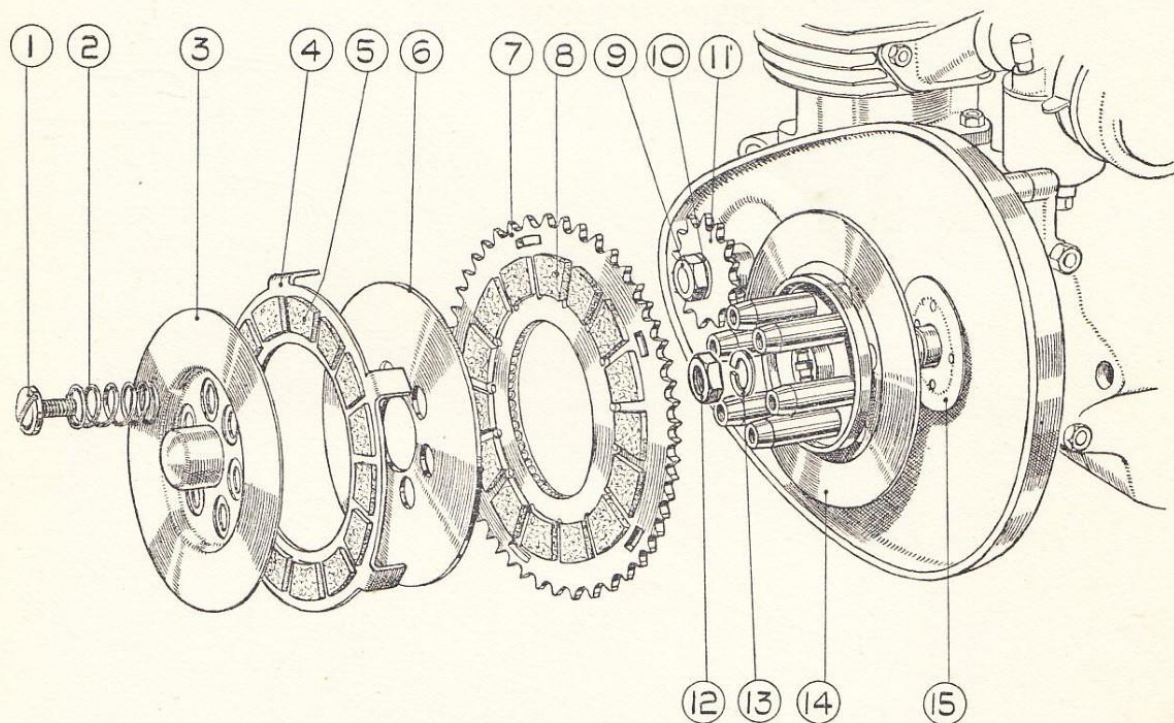

FIG. 13.

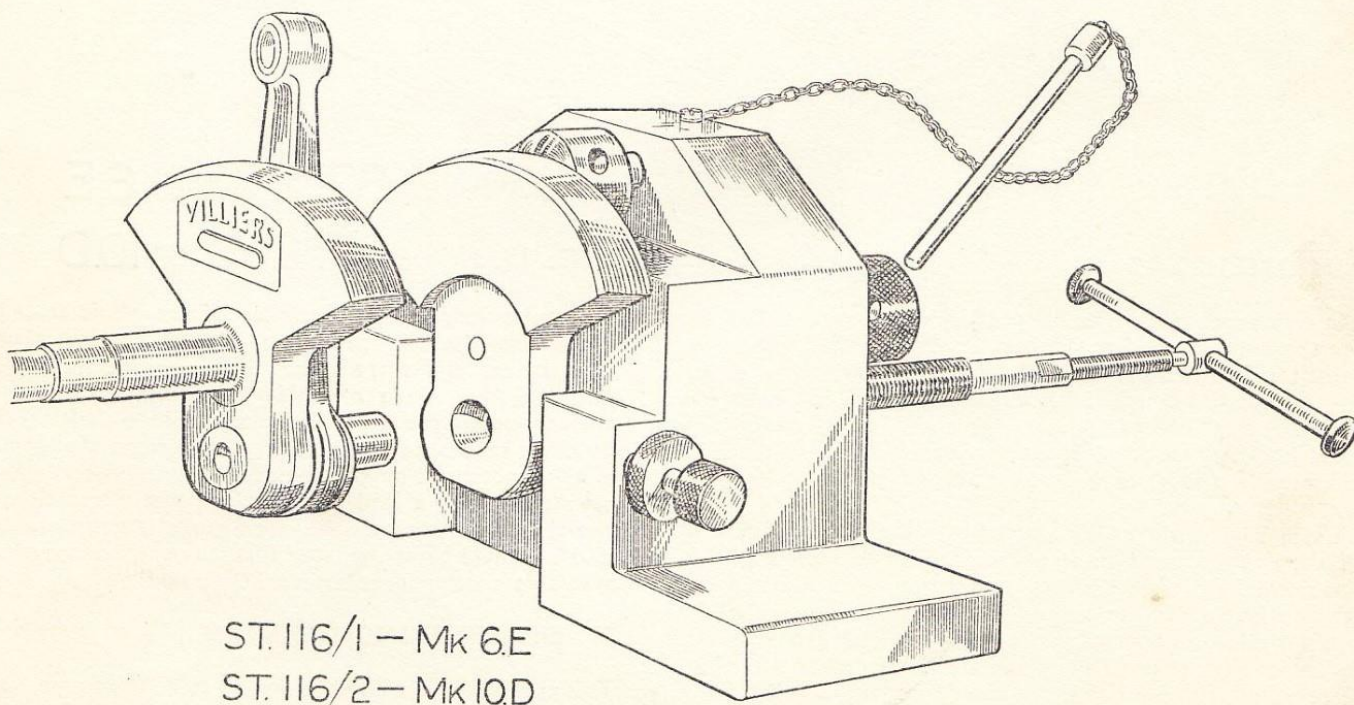
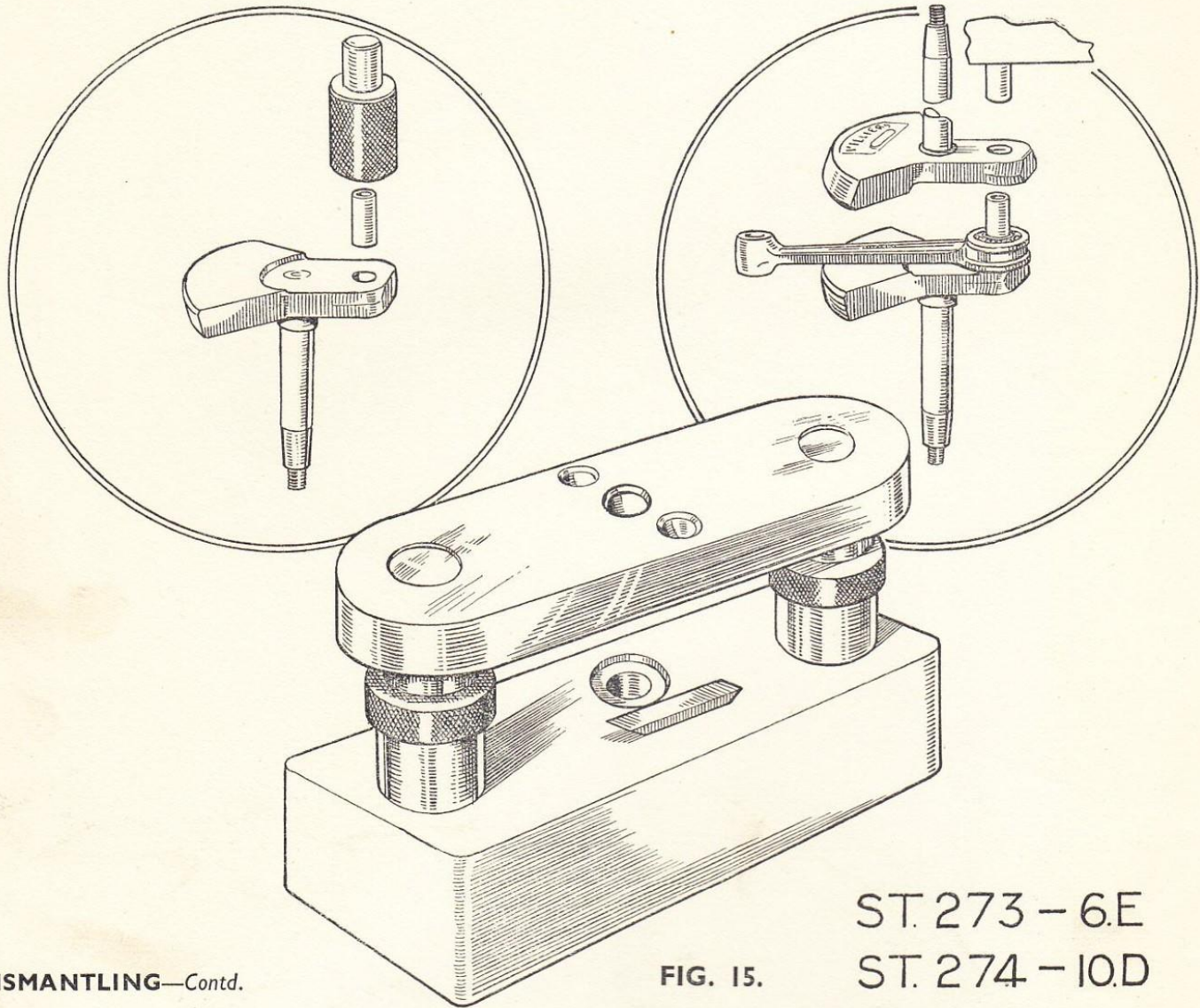

FIG. 14.

VILLIERS MK. 10D. & 6E. UNITS

DISMANTLING UNIT



ST. 273 - 6E

ST. 274 - 10D

DISMANTLING—Contd.

an interference hole. The connecting rod is next fitted over the crankpin and the rollers inserted. On the 6E. engine there are two rows of $\frac{1}{4}$ " diameter rollers, $\frac{1}{4}$ " long, 13 in each row. On the 10D. engine there are two rows of 6 each, steel rollers, $\frac{1}{4}$ " diameter and $\frac{1}{4}$ " long. Interspaced in each row are 6 bronze rollers $\frac{3}{8}$ " long, so that the assembly comprises alternate steel and bronze rollers.

Ordinary engine oil is then poured into the roller track, and then the other side of the crankshaft is placed on to the crankpin and lined up as accurately as possible with the first shaft. It is then pressed home on to the crankpin using a gauge of pen steel .010" thick between the face of the connecting rod and the crankshaft. After the removal of this gauge there should be between .004" and .007" clearance. The pressure in assembling the crankpin must obviously be applied directly over the crankpin and not on the centre of the driving shaft, as this

FIG. 15.

will cause very severe distortion of the whole assembly. After this assembly process a truing fixture is used. The driving shafts are placed between centres (see Fig 16), and the whole assembly is rotated by means of the connecting rod and the alignment of the shaft checked by clock gauges, as illustrated. Correctness of alignment is then obtained by tapping the balance weight of the crankshaft with a lead hammer until the eccentricity of the shafts as shown on the clock gauge is not more than .001". It will be appreciated that it is only by experience that this truing process can be carried out effectively.

27 DISMANTLING GEARBOX.

This can be done while the engine is in the frame, but if the gearbox has been separated from the engine it is best to mount the gearbox on a fixture (S.T.246) Fig. 18, having four studs similar to those used for securing the gearbox

VILLIERS MK. 10 D. & 6 E. UNITS

DISMANTLING UNIT

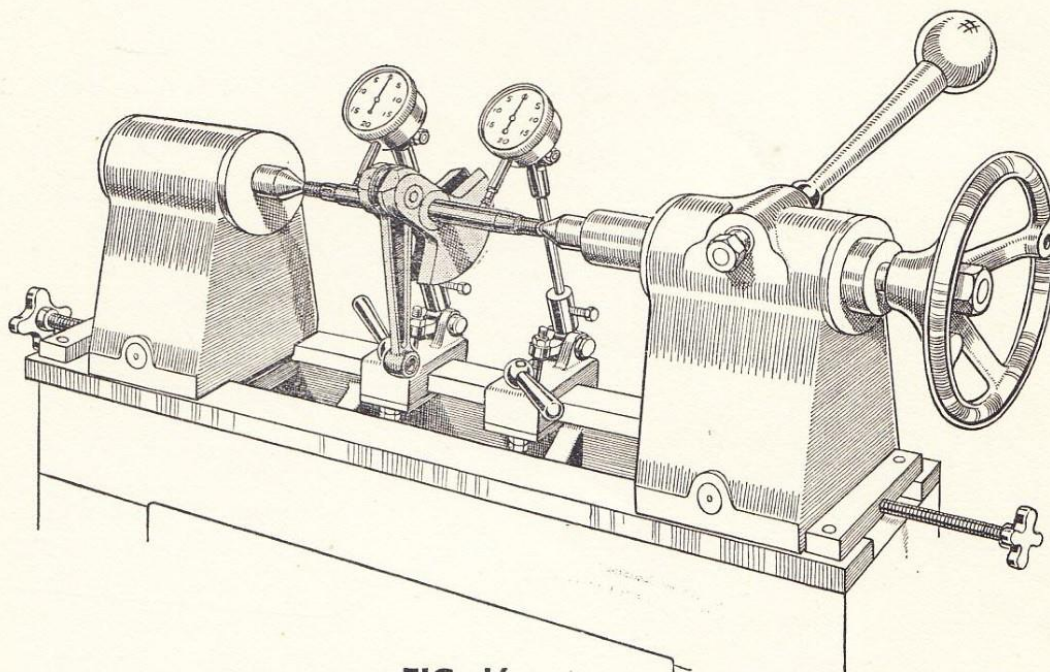

FIG. 16.

to the engine (Fig. 4, No. 29). First remove the kick starter lever and foot change lever by removing the clamping bolts. Remove the dust cover by taking out the three cheese headed screws. Take off the kick starter spring and cap. Take out the small locking screw which secures the rear drive sprocket nut, and by means of the service locking plate (S.T.126) Fig. 17, which prevents the sprocket turning, unscrew the sprocket nut and withdraw the sprocket from the splines. Next remove the gearbox end cover. There are three hexagon nuts and three cheese headed screws. Take care not to lose the small washers to be found in the recesses of the fixing screw holes. When withdrawing the end cover keep the gears in position in the box by inserting a screw driver between the box and the cover as it is withdrawn, and also by holding the thumb on the end of the kick starter spindle. This will prevent the gears from falling out. The footchange assembly will remain in position if the circlip (Fig. 21) is not removed. It is advisable to undo the large hexagon cap nut of the plunger box near the bottom of the cover and remove the spring and plunger which will be found inside, otherwise these parts may shoot out and be lost. It will also facilitate re-assembly.

It is now possible to remove the mainshaft, layshaft and sliding gear without removing the selector fork by slightly tilting the shafts upwards when they have been withdrawn from the bearings in the bottom end of the box. The kick starter spindle will slide off the layshaft. Examine the pawl for wear before replacing. The striking plate should now come away with the pair of sliding wheels.

If it is desired to remove the selector fork for replacement

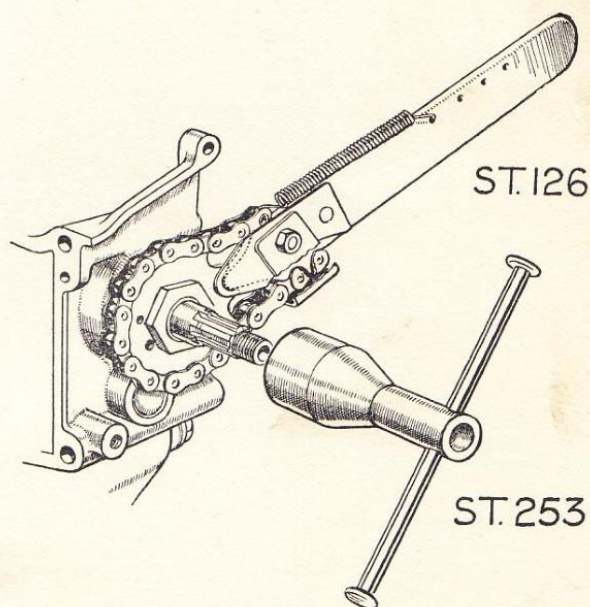

FIG. 17.

or inspection, it can be done by removing the spindle, the hexagon head of which is to be found at the rear of the gearbox body. Take care not to lose the thick washer from underneath the head. The high gear wheel can be tapped out of the bearings with a wooden or leather mallet.

If it is necessary to remove the ball race use an extractor

VILLIERS MK. 10D. & 6E. UNITS

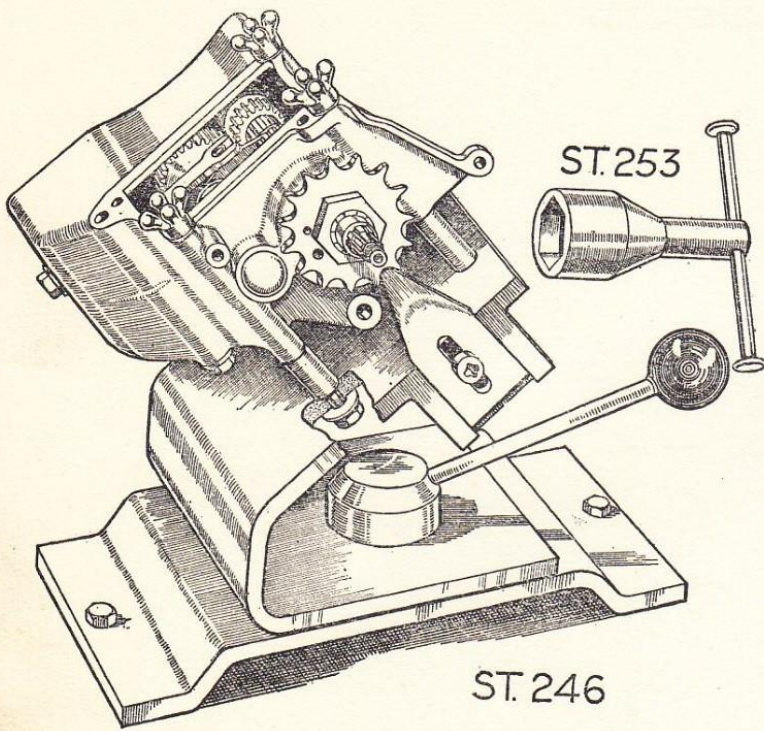

FIG. 18.

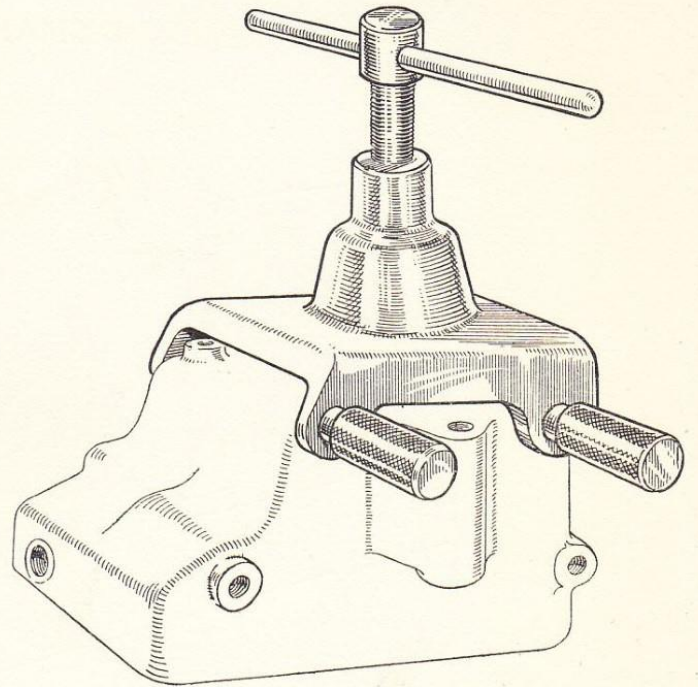
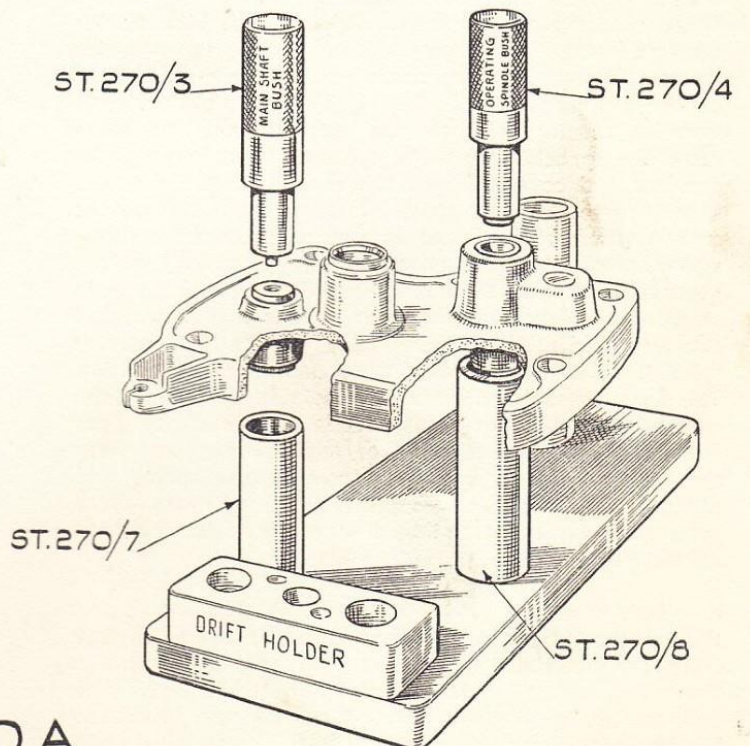
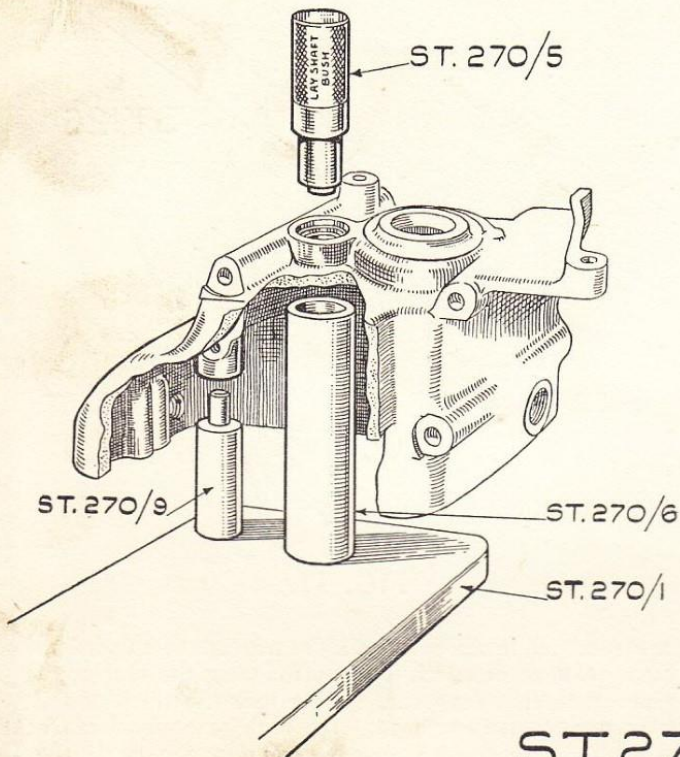

FIG. 19.



ST.270A

FIG. 20.

VILLIERS MK. 10D. & 6E. UNITS

DISMANTLING UNIT — GEAR AND ENGINE ASSEMBLY

DISMANTLING—Contd.

(S.T.271) as shown in Fig. 19, or push out under the small press.

If it is necessary to replace the layshaft bush in the gearbox, knock out the disc that seals the outside of the hole by tapping from the inside of the box, then press the bush from the outside of the box, using tool (S.T.270A) Fig. 20. After replacing the bush press back the disc into the recess to seal the hole, using tool (C.6617) Fig. 44.

28 FOOT CHANGE ASSEMBLY.

Unless it is absolutely essential we do not recommend that the foot gear change mechanism should be disturbed, but if this is necessary for replacement of any of the parts, proceed as follows.

Take off the circlip outside the cover on the end of the foot gear change spindle. This is best done by means of a pair of special pliers (Fig. 21), which will open the ends of the spring and enable it to be lifted out of the groove.

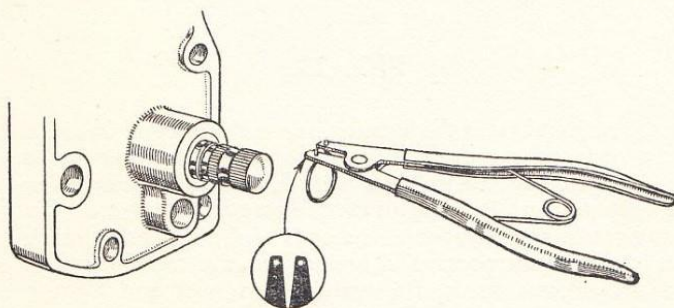

FIG. 21.

The shaft will then slide out of the box complete with all the ratchet members. In order to completely strip down the shaft turn down the locking plate tang and remove the hexagon nut. Note correctly the position of all the parts before dismantling as it is very easy to assemble incorrectly, which will prevent the mechanism from working at all. Do not lose or damage the phosphor bronze packing shims (No. 40, Fig. 5) found underneath the washer with the "D" shaped hole.

Before re-assembly make sure that the face teeth on both the ratchet members are not damaged. Do not attempt to remove the "D" shape stop pin which is pressed into the gearbox cover. The slotted nut and screwed sleeve fitted at the outer end of the main shaft bush in the gearbox cover will normally not require any adjustment. These parts are used to give a slight end clearance to the main shaft and when re-assembled the amount of visible end-wise movement should be checked. It is absolutely essential that this sleeve should not be adjusted so as to prevent this freedom, as otherwise severe wear may take place on the thrust washer fitted between the main shaft

spline and the high gear wheel. Care should be taken to see that the two thin steel washers with the felt ring between remain in the bottom of the main shaft bush together with the short operating clutch rod.

29 BALL BEARINGS.

The bearings should be examined before re-assembly to ascertain whether they require replacement, as the result of wear. Generally speaking, wear will only occur due to dust or other foreign matter reaching the ball track, or through insufficient lubrication. The bearings should spin freely without harshness, and of course, without appreciable radial slackness. If it is found necessary to replace these bearings, it should be noted that the type having the correct initial clearance is used. Bearings are obtainable with different degrees of initial radial clearance, usually denoted on the side of the bearing by ground circles, and are known as 1, 2 or 3 spot bearings. The object of this is to indicate the amount of initial clearance on the ball track. The type required for this engine is the 3 spot, which has the greatest radial clearance and permits the required degree of interference of the bearing on the crankshaft and in the bearing housing, without exerting any initial pressure on the ball track after assembly.

In the assembly of the bearing it is essential that the inner and outer members should be started absolutely square with the shaft or housing, as otherwise it would be impossible to fit the bearing correctly. The load required to fit the bearing in the housing should always be applied on the outer race, and the inner race should be supported while pressing the shaft into the bearing. If this is not done correctly, there is a very serious danger that the ball track may be indented, which will make quiet running quite impossible, and will lead to rapid failure of the ball track.

30 TO RE-ASSEMBLE ENGINE.

Before commencing to re-build the engine make sure that all parts are scrupulously clean. Proceed as follows.

Fit ball races to the driving shaft by supporting the shaft on a "U" shaped bracket (S.T.243), the support being between the crank cheeks (see Fig. 23). Press on the ball races to the shoulders. Examine the gland bush and its seating in the left half crankcase. Its surface should be clean and smooth and flat.

Heat the crankcases in boiling water, fit gland bush and spring, taking care that the spring is fitted with the tangs downwards pressing on to the gland bush. It should be noted that the gland bush is a close fit on the shaft but a free fit in the crankcase, and unless this bush is placed central in the housing some difficulty may arise when the bearings already fitted to the shaft are inserted in the crankcase because the end of the shaft may not enter the bore of the gland bush. If the crankcase is supported so

VILLIERS MK. 10D. & 6E. UNITS

ENGINE AND GEARBOX ASSEMBLY

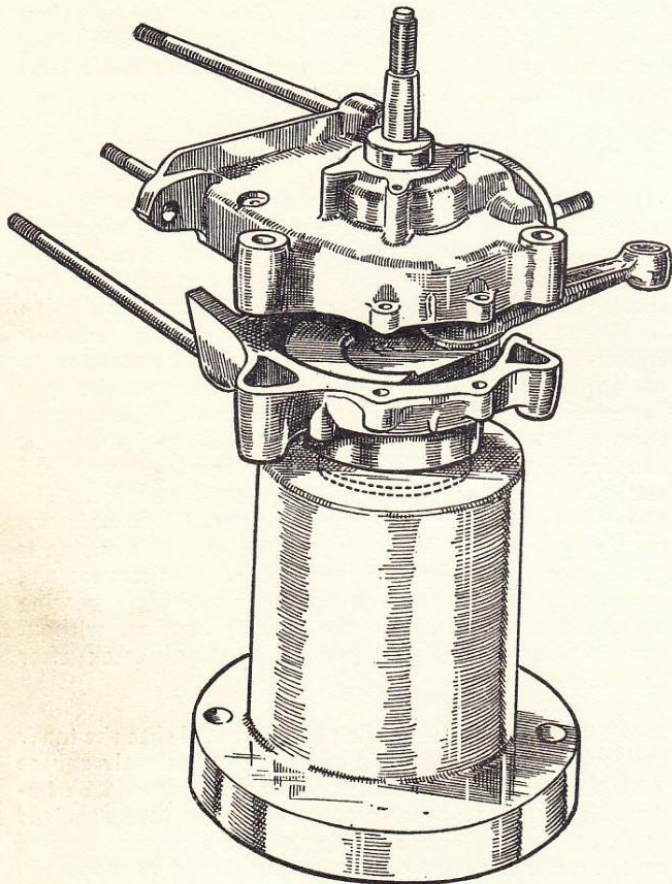

ST. 272

FIG. 22.

ENGINE ASSEMBLY—Contd.

that its joint face is horizontal, this difficulty can be avoided, and there will be no tendency for the gland bush to fall to one side. See S.T.272 (Fig. 22). Apply seccotine to the joint faces and assemble the crankcases on to the crankshaft bearings and bolt up tightly. Make sure the crankshaft revolves freely.

Fit cylinder base joint washer, fit piston and gudgeon pin, taking care to see that the piston is fitted in the same direction as it was removed, that is with the same faces in contact with the cylinder wall. Replace the circlip, making sure that it is fitting correctly in the groove. If a new piston has been fitted, fit two circlips.

Next replace the cylinder, smear plenty of oil around the piston and in the bore of the cylinder. Slide the cylinder correctly over the piston rings noting that the gap in

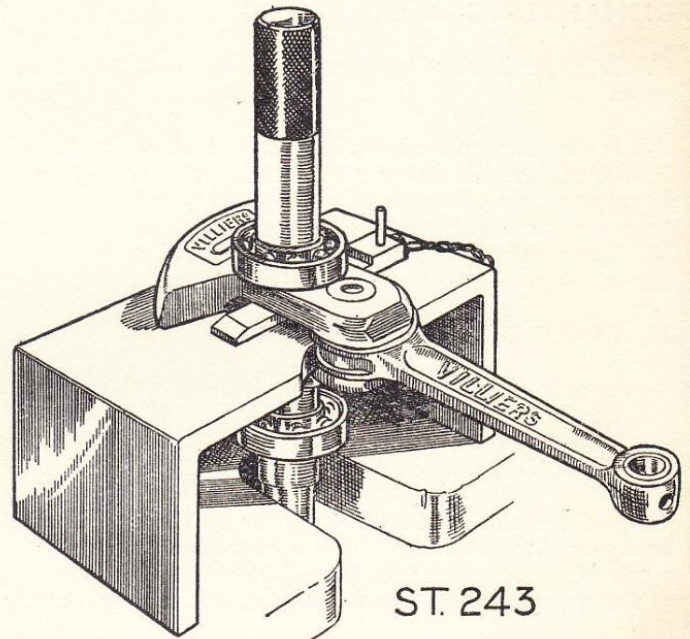

ST. 243

FIG. 23.

each ring embraces the locating peg in the piston. Squeeze the rings up correctly as each one enters the chamfer at the bottom of the cylinder barrel, assemble the cylinder in the position it occupies on the assembled engine. Do not rotate the cylinder as the ends of the rings may catch in the cylinder ports, and break. Fit the cylinder on to the crankcase studs, fit washers and nuts and tighten each equally.

Fit the armature plate to the right-hand side of the case, taking care not to damage the rubber oil seal when assembling. Secure by means of the four countersunk headed screws. These should be securely tightened. Clean all traces of oil from the taper shaft and also from inside the taper hole in the flywheel cam, otherwise insufficient grip will be obtained to prevent slipping. Assemble the flywheel on the shaft, screwing the nut up lightly, then time the ignition by setting the piston at top of the stroke. Turn the flywheel without moving the piston until the marks on the flywheel and armature coincide (see Fig. 24). Tighten centre nut. Check to see that the flywheel has not slipped, and then finally tighten, using the hammer-tight spanner. Re-fit cylinder head. Tighten each bolt finger tight, and then finally tighten each bolt in turn until all are tight.

31 ASSEMBLY OF GEARBOX.

Before re-assembling any parts make sure that all the components are perfectly clean. Assemble the high gear wheel ball race by heating the gearbox in boiling water. Use fixture No. B.6618, Fig. 45, to guarantee that

VILLIERS MK. 10D. & 6E. UNITS

ENGINE AND GEARBOX ASSEMBLY

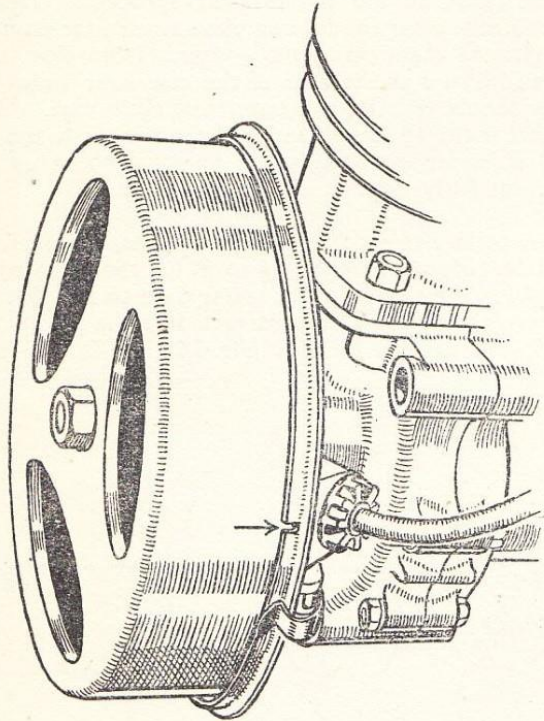

FIG. 24.

the bearing is fitted square in the housing. Assemble the high gear wheel (No. 20, Fig. 5) with a hand press, using a sleeve fitting through the ball race to ensure that the gear wheel is true D.7499, Fig. 46. Loosely fit the rear drive sprocket and nut. Assemble the main shaft and layshaft together with the pair of sliding wheels and the striking plate. Make sure that the high gear wheel pressure washer (No. 19, Fig. 5) is on the end of the splines of the main shaft. Note that the low gear wheel fixed pinion (No. 17, Fig. 5) on the main shaft is wider than the fixed pinion (No. 46, Fig. 5) on the layshaft. See that the sliding wheels are fitted correctly. The main shaft sliding wheel has dogs on the end of the gear mating with slots in the high gear wheel. The layshaft sliding wheel has dogs on the flange embracing the striking plate mating with the kick starter ratchet wheel. Make sure that the striking plate is fitting correctly between the sliding wheels and assemble the gear unit complete into the box. If the selector fork has not been removed a little tilting of the shafts upwards will be necessary to engage the projecting pegs of the striking plate into the slots in the selector fork. If the selector fork has been removed it can be re-fitted by inclining it slightly, and engaging the fork ends with the projecting pegs on the striking plate, and then inserting the selector fork pivot pin not omitting the thick washer. Set the selector fork in an upright position in the gearbox, that is with the sliding gears midway between the ends of the gearbox (the middle gear position).

Next fit the foot change ratchet mechanism to the gearbox cover, as shown in Fig. 5. Note carefully the exact position of all the parts and assemble into cover in the position shown. Do not omit the spring which keeps all the parts compressed together. Hold the complete assembly into the cover and fit the circlip to the outer end of the shaft using the special pair of pliers as shown in Fig. 21. Next fit the kick starter shaft to gearbox cover with the pawl depressed and the shaft rotated against the stop. Seccotine the cover joint and assemble on to the gearbox making quite sure that the two steel and felt washers are still in the bottom of the main shaft bush. Be quite certain that the slot in the ratchet mechanism (No. 39, Fig. 5) engages with the ball on the selector arm, tap the gearbox cover into position, fit washers in the screw recesses, the nuts and screws, and see that all are tightened securely. The plunger and spring for locating the gears should now be replaced and the cap nut securely tightened. The kick starter lever, spring and spring box should now be re-fitted. The short tang on the spring should be inserted in the middle one of the three holes. With the kick start shaft against its stop, place the lever on the end of the serrations so that it occupies a position at an appreciable angle from the vertical (about 15°)—if this angle is too small it will damage the clutch adjusting screw in its return movement. Wind up the spring cover until the protruding end of the spring will enter the hole in the lever, then push the lever along the serrations up to the shoulder, and thread the dust cover over the lever. This is best done with the lever in a horizontal position. The clamping bolt can now be fitted. Re-fit the dust cover with the clutch operating lever in position. Secure with three cheese headed screws. Next tighten the sprocket locknut by mounting the gearbox on the fixture originally used for dismantling, the sprocket being prevented from turning by means of the service locking plate. Tighten securely and fit locking screw. Make sure that the gearbox shafts revolve freely and that the dog and spline engagement is correct in all gears.

32 ASSEMBLY OF ENGINE AND GEARBOX.

Re-fit the engine, gearbox, joint washer, on to the three studs on the crank case. If this washer appears to be damaged or in any way unserviceable it is advisable to fit a new washer. With the engine mounted on the special fixture assemble the gearbox on to the three studs and bolt up tightly, making sure that the dowels enter their appropriate holes in the gearbox. Next fit the joint washer around the boss on the left-hand side of the crankcase, the inner half of the chaincase can then be fitted. This is by means of the stud at the top and a large domed nut on the locking plate and locking screw near the clutch centre. Next replace the clutch back-plate, the $\frac{7}{16}$ " spring washer and tighten the nut tightly, using the service locking plate to prevent the clutch centre from turning. The clutch back plate should run true. If it does not, try fitting it to a different spline until it runs as true as possible. Fit two lengths of push rod, the plain one and then the headed one. Fit any

VILLIERS MK. 10D. & 6E. UNITS

ENGINE AND GEARBOX ASSEMBLY

ENGINE AND GEARBOX ASSEMBLY—Contd.

packing shims that were removed on to the engine driving shaft. Fit the engine sprocket key and slide the sprocket over the key. Next take the clutch chain wheel complete with chain and fit the chain over the engine sprocket. Assemble complete on to the clutch centre. Check the chain sprockets for alignment by means of a straight edge or steel rule. If the alignment was correct before dismantling it should not have altered. The remaining parts with the clutch can now be assembled. First the plain centre plate, then the tanged cork plate, the tangs fitting into slots in the clutch chain wheel. Finally fit the clutch outer plate, six springs and the spring screws. Tighten these very tightly. The spring washer and $\frac{1}{2}$ " nut can

now be fitted to the engine shaft sprocket. Tighten very securely, using the locking plate as used for dismantling. Fit the chain case joint washer. Note that there is a small dowel at the rear of the case over which the washer should fit. Fit the outer half chain case. Make sure that it fits all round, and that the washer is not displaced either in or outside the joint. Tighten up the centre nut fairly tightly.

If it is necessary to recork the clutch plates, the thickness should be reduced by grinding to $\frac{3}{8}$ " for the chain wheel and $\frac{5}{16}$ " for the tanged plate, taking care to see that the corks project an equal amount each side the plate. See S.T.139 (Fig. 25) and S.T. 140 (Fig. 26).

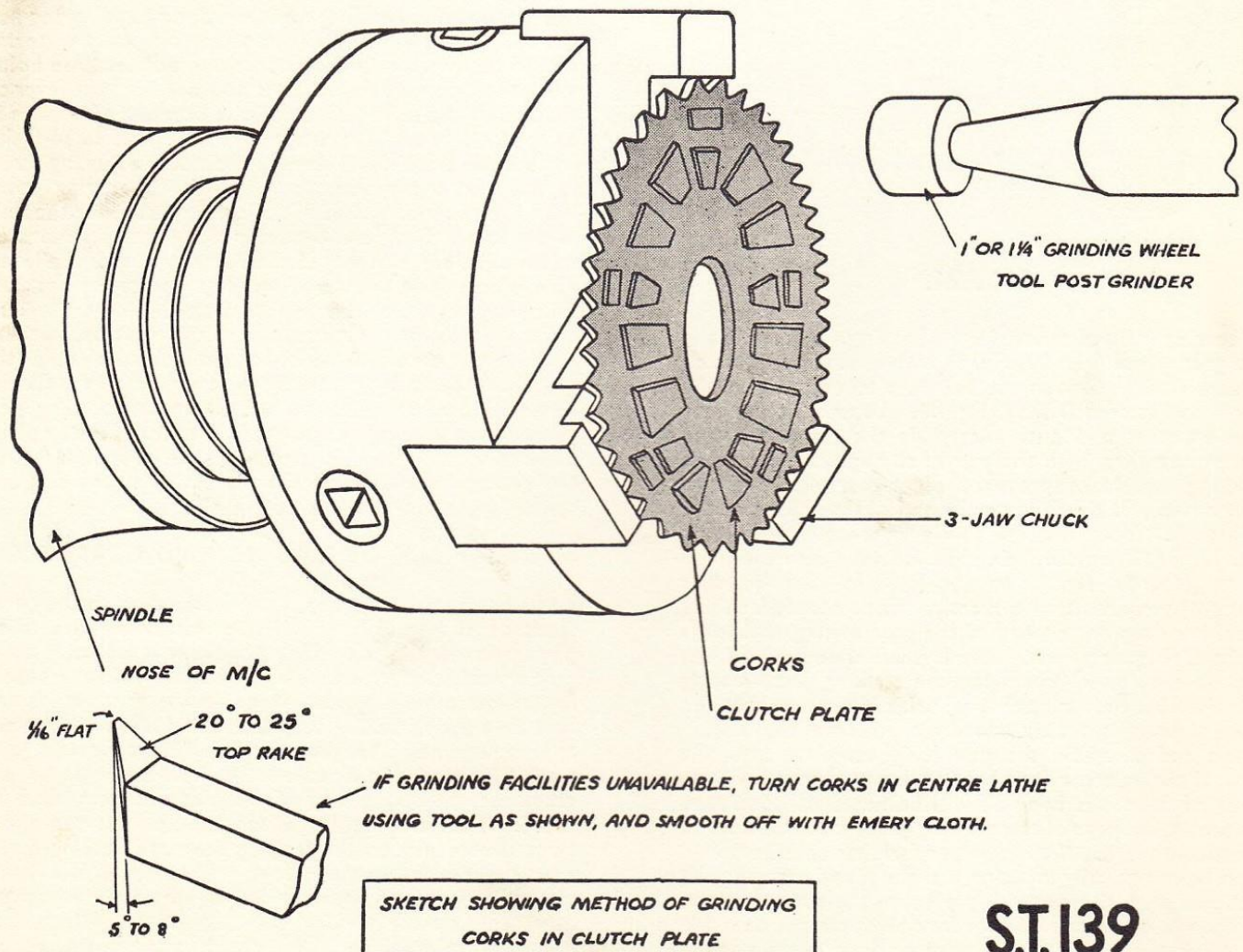

S.T.139

FIG. 25.

VILLIERS MK. 10D. & 6E. UNITS

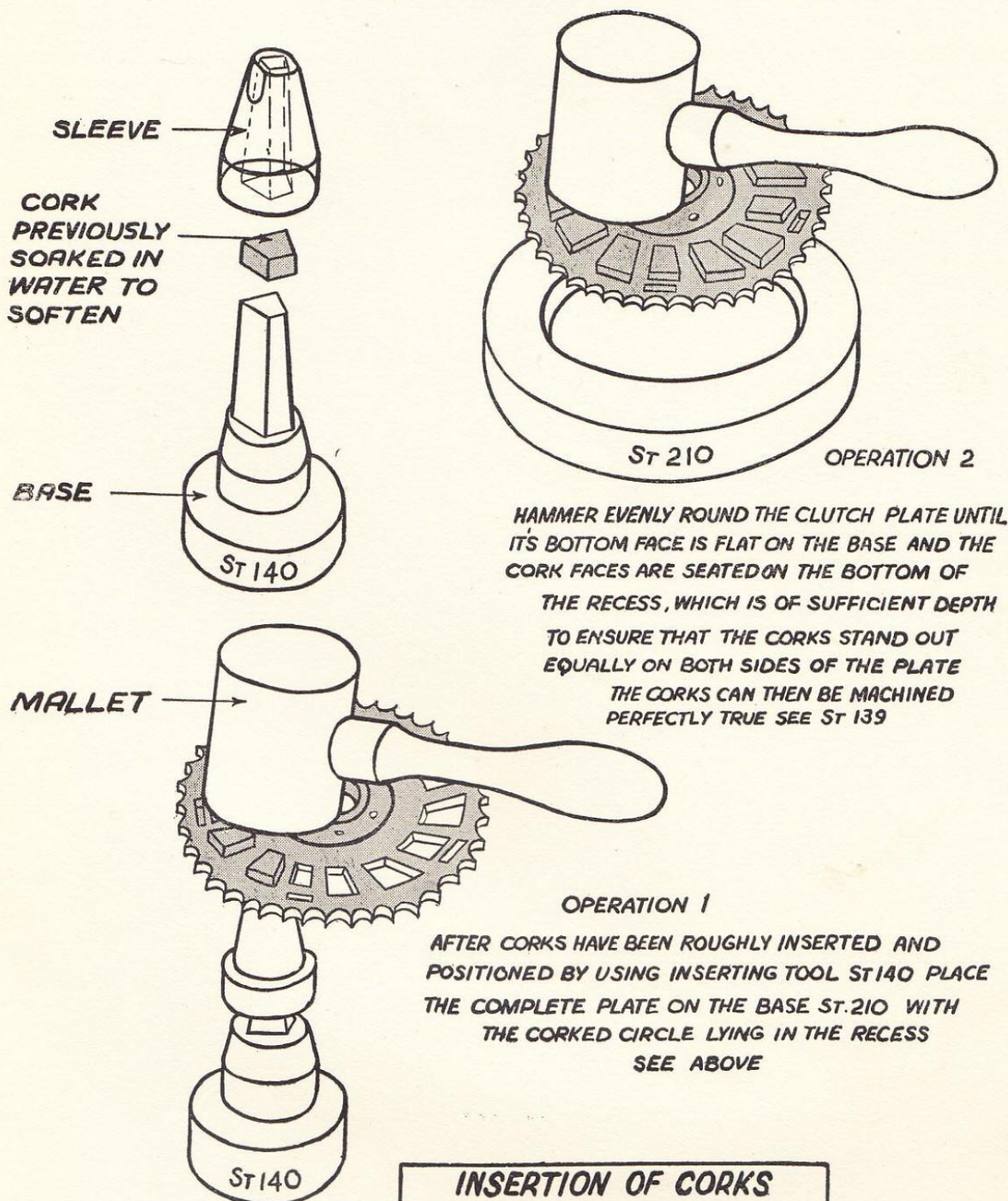

**INSERTION OF CORKS
IN CLUTCH SPROCKET**

ST.140

FIG. 26.

VILLIERS MK. 10D. & 6E. UNITS

NOTES

VILLIERS MK. 10D. & 6E. UNITS

CARBURETTER

33 CARBURETTER.

The Villiers type 3/4 carburetter (Fig. 27) is fitted to the Mk. 10D. engine, and a type 4/5 two-lever carburetter to the Mk. 6E. engine. These numbers will be found stamped on the inlet stub immediately behind the clip (No. 19 Fig. 27/28). The setting of the carburetter will be done by the maker after road testing the machine, and it should not be necessary to make any alteration except in exceptional conditions.

34 THE OPERATION OF THE CARBURETTER.

The function of the carburetter is to supply a mixture of fuel and air in correct proportions under all running conditions. In the Villiers carburetter, the float chamber (No. 25, Fig. 27) surrounds the jet centre piece (No. 23) and in it an annular float (No. 24) rises as the fuel enters the chamber until the correct level is obtained, then the fork lever (No. 5) which rests on the top of the float lifts the fuel needle (No. 6) which has a conical end and shuts off the fuel supply by closing the hole in the bush.

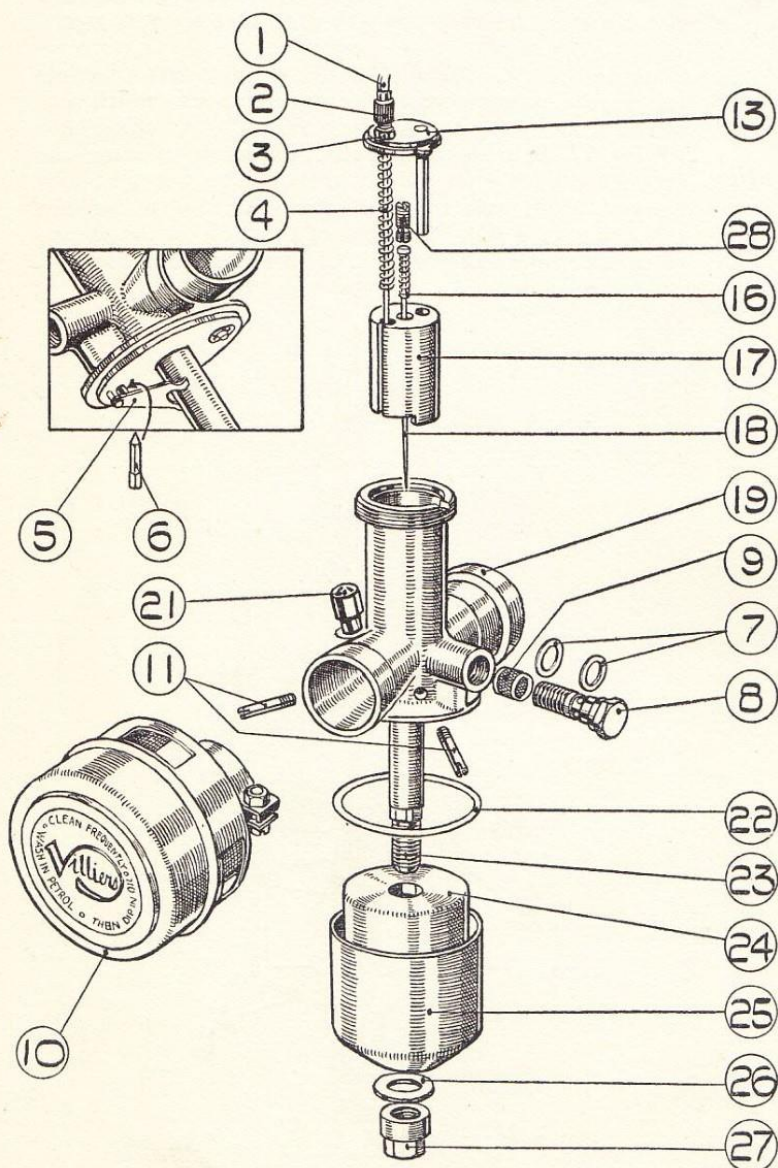

FIG. 27.

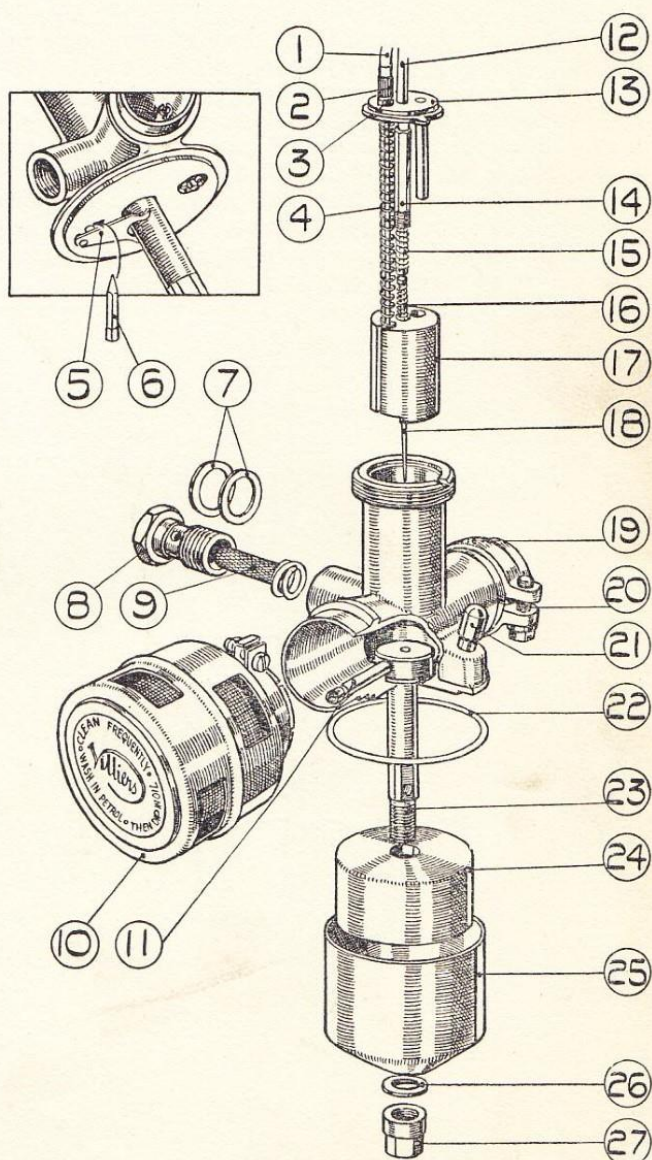
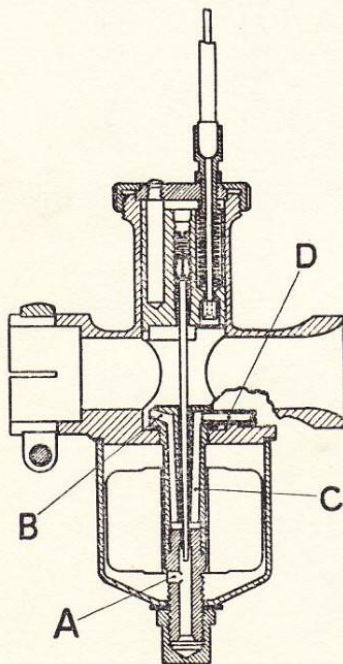

FIG. 28.

VILLIERS MK. 10D. & 6E. UNITS

CARBURETTER

In the Mk. 10D. carburetter fuel enters the jet body through a hole (A) Fig. 29, and passes through the jet in which the long taper needle operates, and passes up through an offset hole (B) in the centre piece. The position of this needle relative to the slide can be altered by removing the screwed ring and top disc and screwing up or down the small screw in the centre of the slide. Screw in the screw to weaken the mixture, i.e., lower the needle. Screw out the screw to richen the mixture. The screw should not be loose in the throttle slide as it is likely to move and alter the setting. It is split to make it grip the hole. Should the screw be loose the split portion should be gently prized apart. Note the taper needle spring should be fitted with the small coil under the head of the needle. The slide (No. 17, Fig. 27) operated by the throttle cable controls the air supply and is fitted with taper needle (No. 18) which extends below the slide through the centre piece and into the needle jet. When the throttle slide closes the air supply the largest diameter of the needle nearly closes the fuel outlet, but when the slide is lifted admitting more air, the smaller diameter of the needle now in the jet allows more fuel to pass. A suitable combination of jet size, needle position and taper will give a correct mixture strength at all throttle openings.



Mk. 10-D

FIG. 29.

In the 6E. carburetter fuel enters the centre piece through hole "A," or in some machines through a limit jet screwed into the hole "A" in needle jet body through which the long taper needle operates. The position of this needle can be varied by means of the jet needle control lever on the right-hand handlebar, the needle being raised to richen the mixture and lowered to weaken. The slide (No. 17) operated by the cable opens up the air supply and carries with it the taper needle. When the throttle slide closes the air supply, the largest diameter of the needle nearly closes the needle jet orifice, and when the slide is lifted admitting more air, the smaller diameter of the needle is in the jet and allows more fuel to pass. A suitable combination of jet size and needle taper will give a correct mixture strength at all throttle openings.

On both the Mk. 10D. and Mk. 6E. carburetters a further refinement to compensate for engine speed, which also assists in atomising the fuel is provided. The offset hole (C) Fig. 27/28, in the centre piece allows air to enter just above the needle jet, which it should be noted is submerged. This hole communicates with the atmosphere through a tube (D). The size of this hole in the centre piece determines the amount of correction provided.

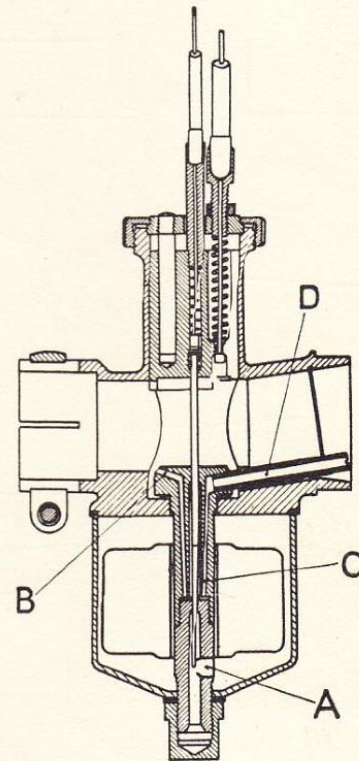

Mk. 6-E

FIG. 30.

VILLIERS MK. 10D. & 6E. UNITS

CARBURETTER

35 SERVICE.

The fuel level is maintained by the float and needle valve and in no circumstances should any alteration be made to this by bending the float lever or altering the needle length. The needle jet is not detachable from the centre piece, and is not supplied separately. In the case of the Mk. 6E. a limit jet can be supplied separately. The carburetter is automatic in action and gives a correct mixture strength over the whole range of throttle opening, the only available adjustment being the position of the taper needle in the throttle which controls the size of the jet orifice, and which is necessary to suit individual engines. The needle controls the mixture strength from tick-over to approximately two thirds throttle, the jet controls the remainder.

36 TO DISMANTLE THE CARBURETTER.

To remove throttle slide from the body open throttle lever to the full extent, undo the top screwed ring, when the throttle slide complete with the top disc can be withdrawn. Take care not to damage or bend the taper needle. If it is necessary to detach the throttle control cable turn the control lever to the fully closed position, compress the throttle spring. The nipple on the end of the cable can then be pulled out of the recess and the cable withdrawn through the slot in the side of the slide.

To dismantle the taper needle (on the 6E. only) unscrew the long hexagon rod which will be found in the top of the slide. After having removed this, the taper needle will slide out. Take care not to lose the small spring from underneath the head of the needle.

37 TO REMOVE CENTRE PIECE AND FUEL NEEDLE.

Unscrew the bottom nut (No. 27, Fig. 27/28) underneath the float chamber cup.

Next remove the fibre washer (No. 26), the cup (No. 25) with float inside, and if loose, the fibre washer (No. 22) between cup and carburetter body.

Then remove the centre piece compensating tube situated below and to the rear of the banjo petrol pipe on the Mk. 10D. and inside the air intake on the Mk. 6E. Do not lose the spring locking wire from the Mk. 6E. The centre piece (No. 23) with fibre washer under head can now be pushed up through the throttle bore.

When the centre piece is removed, the fuel needle lever (No. 5) can swing round and will thus allow the fuel needle (No. 6) to drop out of its seating; the needle should, therefore, be removed at the same time as the centre piece and kept in a safe place until required for re-assembly. No attempt should be made to remove the fuel needle lever from the carburetter body.

38 TO REMOVE TICKLER.

This should not be necessary unless the vent hole in base of body is blocked, in which case remove the split cotter pin at end of tickler, which will release the tickler and its spring.

One vent hole is at bottom of the hole where the spring fits, the other being in the side of the tickler cap.

39 TO REMOVE AIR CLEANER.

The air cleaner which is held on to carburetter body by a clip, should be removed approximately every 2,000 miles and cleaned by immersing in gasoline; when dry, dip in thin machine oil and allow to drain before re-fitting.

40 RE-ASSEMBLY OF CARBURETTER.

This, of course, is the reverse process to that described; the fuel needle should be fitted point first, the fuel needle lever should then be placed so that it will hold the needle in position while the centre piece is replaced. Care should be taken to see that the centre piece complete with fibre washer is fitted so that the compensating tube will screw in the head of the centre piece. Do not forget to re-fit the spring locking wire on the Mk. 6E. compensating tube. When re-fitting float cup do not over tighten bottom nut as this may distort the jet.

41 CARBURETTER SETTING (MK. 10D.).

This carburetter is fitted with a taper needle marked "3" on the parallel portion underneath the head, a centre piece marked "3," and the jet which is not detachable marked "3" on the hexagon portion. The normal needle setting is $2\frac{13}{32}$ " from the bottom of the throttle slide to the end of the needle, but this is usually a matter of individual adjustment to each engine.

42 CARBURETTER SETTING (MK. 6E.)

The needle setting for the Mk. 6E. carburetter is controlled by the handlebar lever. The needle is No. 4 $\frac{1}{2}$. The centre piece is marked "1" on the head and the jet marked "1" on the hexagon portion.

43 CARBURETTER TUNING HINTS.

Erratic running at low speeds may be due to :

Air leaks, either at carburetter stub joint, due to carburetter not being pushed home, cylinder base joint, crankcase joint face or gland bush.

Ignition too far advanced.

Sparking plug points too close, corroded or dirty.

Contact breaker points dirty, pitted, loose or set too closely.

High tension wire defective.

VILLIERS MK. 10D. & 6E. UNITS

CARBURETTER

WEAK MIXTURE.

This may be caused by choked gauzes in petrol supply system. After considerable mileage, wear of the throttle slide and/or carburetter body may cause weak mixture.

Heavy petrol consumption may be due to :

Late ignition setting.

Carburetter flooding due to leaking float, or bad seating of fuel needle and bush. This may be caused by dirt or wear. A worn fuel needle bush can be replaced by drilling out and fitting oversize bush, but this is rarely necessary.

Worn jet or centre-piece hole and/or taper needle, usually after considerable mileage. Remedy is to replace worn parts.

Taper needle adjustment too rich.

Poor compression due to worn piston rings and/or worn cylinder bore.

General.

Choked silencer and exhaust system. Incorrect petrol-oil mixture, *i.e.*, more or less than half pint of oil to one gallon of gasoline, also high altitudes may have an effect on carburation.

45 CARBURETTER CABLE ADJUSTMENT.

A certain amount of slack may develop in the throttle cable after a time; this can be taken up by means of the adjuster on the top of the carburetter (No. 2, Fig. 27).

NOTES

VILLIERS MK. 10D. & 6E. UNITS

THE MAGNETO

46 OPERATION OF THE MAGNETO.

The purpose of the high tension magneto is to produce a hot spark across the points of the sparking plug. The voltage required to produce this spark will vary according to the conditions. In a cold engine the voltage may have to be as high as 10,000 volts, but when the engine is warm a voltage of between 4,000 and 6,000 will be sufficient to jump across its plug points. In any magneto there have to be permanent magnets, a high tension coil, contact breaker and condenser. In the Villiers magneto the magnets are secured to the rotating flywheel, and the high tension coils, contact breaker and condenser are stationary.

It is fundamental that in order to produce a current in a coil of wire by magnetic means, there has to be a change of magnetic flux through the coils. This change is produced by the movement of the magnets in relation to the coil. The flux of one magnet in the flywheel is led by means of the soft iron poles and coil ends through the core of the ignition coil, then as the following magnet takes its place, the direction of this flux is violently reversed, due to the change of polarity of this magnet, the poles of the flywheel being N.S. N.S. N.S. The current in the primary windings of the ignition coil, which consists of about 200 turns of fairly thick wire (about $\frac{1}{32}$ " dia.), passes through the contact breaker during the closed period. When the points are opened, which is arranged to take place when the current in the primary is greatest, the sudden interruption of the current produces in the secondary windings (which consist of many thousands of turns of fine wire about .003"), a very high voltage, which is sufficient even at quite low speeds of the flywheel to produce a spark at the plug. The sudden interruption

of the current will produce in the primary windings a voltage tending to cause a spark across the gap of the contact breaker, and a condenser is, therefore, connected across the points to absorb the surplus energy which might otherwise be wasted by severe arcing, and thus reduce the voltage at the plug.

47 MAGNETIC CYCLE OF THE MAGNETO.

The method of flux reversal used in the Villiers magneto is shown in the three diagrams, Fig. 31.

No. 1 shows the magnetic flux path before the reversal which generates the high primary current required.

No. 2 shows this path just before the actual point of reversal, and Fig. 3 shows the path immediately after the reversal.

In No. 1 the flux from magnet (2) is seen to be passing through the coil core from left to right, and being more or less unchanging is generating no current in the primary winding.

In No. 2 the flux of magnets (1) and (2) is seen to be drawn out to breaking point at the left hand coil end.

In No. 3 we see where the flux has broken away from the attraction of the iron mass of the left hand coil end and jumped with extreme rapidity to the iron right hand coil end, where it passes through the coil core from right to left.

This rapid movement of the flux across the primary wires thus generates a high voltage in the primary winding,

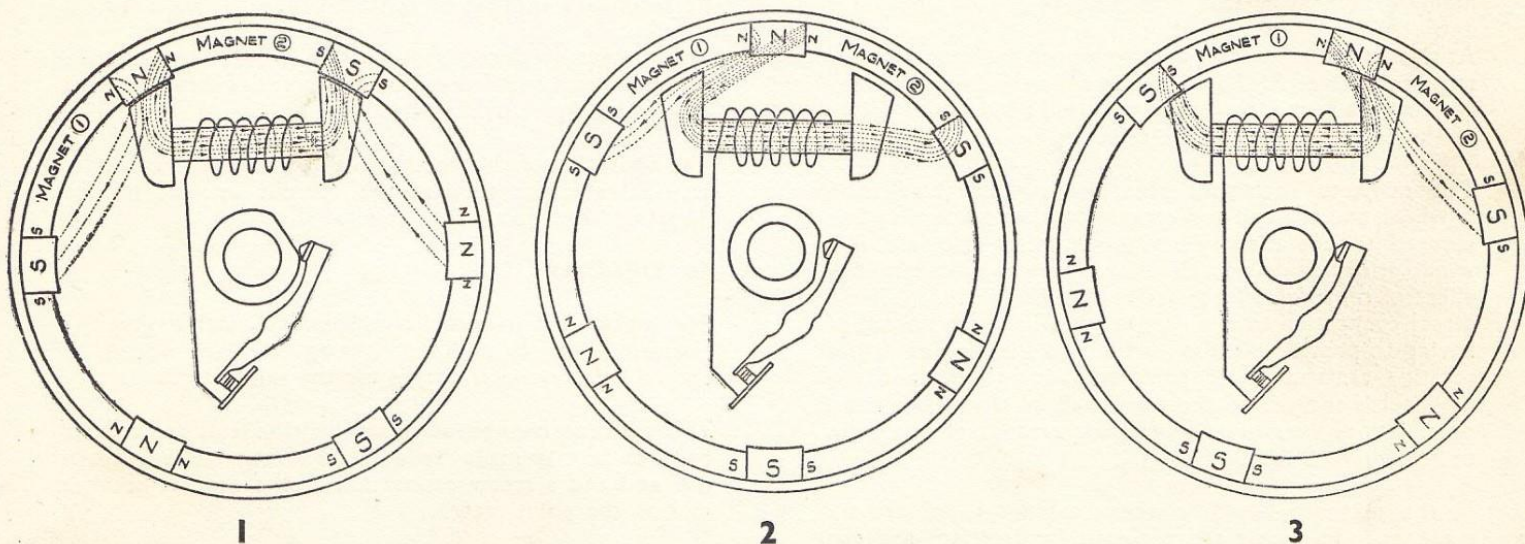

FIG. 31.

VILLIERS MK. 10D. & 6E. UNITS

THE MAGNETO

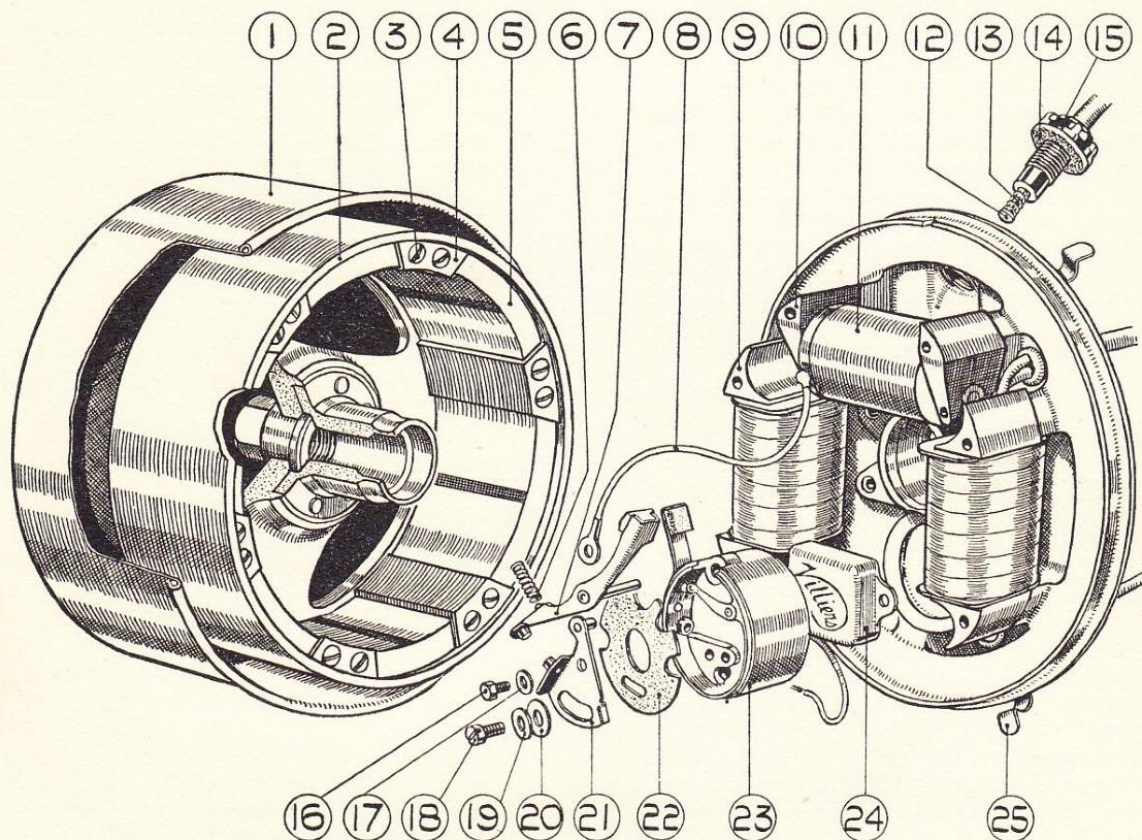

FIG. 32.

making a powerful electro magnet of the ignition coil and causing the fine high tension winding to be enclosed in a highly concentrated magnetic field.

At this point the contact breaker opens and causes a very rapid collapse of this field, generating in this fine secondary winding the very high voltage required to jump the points of the sparking plug in the cylinder.

This magneto comprises rotating magnets fixed in a flywheel, and the coil and contact breaker mechanism are secured to a stationary aluminium plate and the fine windings of coil do not, therefore, have to withstand the effect of centrifugal force. The stationary coil enables a direct connection to the plug wire to be made instead of having to provide a carbon brush and slip ring as with a rotating armature. All parts are very robust and the flywheel is secured to the crankshaft so that there is no possibility of wear or noise which is present when a chain or gear drive is used.

In the magneto fitted to these engines there are six magnets. Two only are required for ignition, and the additional magnets are fitted in order to provide the current for the lighting and battery charging. The same

principles apply to the method by which the lighting current is produced in the lighting coils, but in this case no secondary winding or contact breaker is required.

The current produced is alternating, which by means of a Selenium type rectifier can be converted to direct current so as to charge a 6v. battery.

The operation of this rectifier can be regarded as a one-way valve which permits the current to pass in one direction, but not in the reverse direction.

48 DESCRIPTION.

The ignition coil is wound on a laminated core to give the greatest efficiency and the lighting coils are wound on special "electric iron" cores for the same purpose.

The primary connection from ignition coil to contact breaker box is made by a soldered connection at the coil end and a screw connection at the contact breaker end on the point plate.

The contact breaker is of the latest improved type needing only a screwdriver to adjust. A special thin screwdriver

VILLIERS MK. 10D. & 6E. UNITS

THE MAGNETO — SPARKING PLUG

spanner is supplied with the engine, the spanner fitting the old type of contact breaker point adjustment.

There are two screw holes for the clamp screw in the box so that all conditions of point and rocker arm contact pad wear can be accommodated.

It should be noted that the rocker arm itself is earthed, but that every care must be taken to see that the adjustable point plate is properly protected from the contact breaker box itself by the large insulating washer (22) under the plate; the small insulating washer (20) under the clamp screw brass washer; the small black insulating bush on which the point plate pivots. See Fig. 32.

These parts should be kept clean and free from any foreign matter which might cause electrical leakage and so weaken the ignition spark.

The spindle of the rocker arm runs in a self oiling bush and usually requires no further lubrication.

A felt pad is used to keep the cam in a slightly oily condition, and this is impregnated when new with grease. This can, if visibly dry, be oiled with a small amount of the heaviest oil available. It is better, however, to soak the pad in a molten high temperature grease if it is convenient to detach the box itself for this operation.

If too much oil is put on the felt pad it may creep along the rocker arm, get on the contact points and so cause ignition trouble.

49 SPARKING PLUG.

The plug fitted to the Villiers Mk. 10D. engine is the Lodge H.14 (14 mm. short reach). The American equivalent of this plug is the Champion type J.10 com. The Mk. 6E. engine is usually fitted with a Lodge HHN. (14 mm. short reach) plug. This is not detachable.

These plugs are capable of standing up to the maximum power output of the engine without pre-ignition. Where the machine is being used normally at comparatively low speeds, and it is found that these plugs are oiling up at frequent intervals, a type of plug which runs hotter so that it burns away the oil may be found more suitable, and we would under these circumstances recommend the Lodge H.14 for the 6E. unit. There is, however, a tendency to pre-ignition if these plugs are run at maximum power for long periods.

The chief feature of Lodge "Sintox" insulated plugs is that the insulator is designed to run hot enough to prevent the formation of soot or other combustion deposits, which would give rise to internal shorting and resultant weak sparking. This feature thus gives the plug a self cleaning property and largely obviates the need for plug cleaning. The only servicing necessary (at intervals of approximately 3,000 miles) is that of re-setting the gap to the original size.

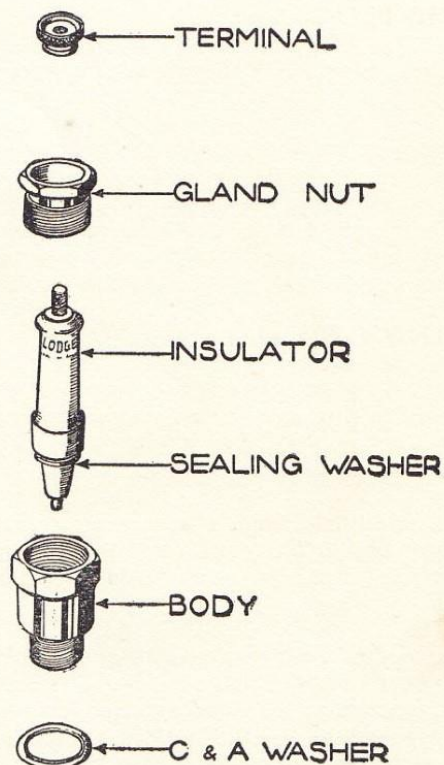

FIG. 33.

Roadside or Home Garage Cleaning of Detachable Lodge Plugs.

1. The plug should be dismantled by unscrewing the gland nut using a ring or box spanner on the smaller hexagon of the plug and holding the larger or body hexagon in another ring or box spanner. The use of two ring spanners, suitably positioned on the respective hexagons so that the ends of the spanners when squeezed together apply an undoing force to the gland joint is an easy method of achieving this dismantling; but the body hexagon can be **lightly** gripped in a vice and a ring or box spanner used on the gland nut in the normal manner.

2. The insulator can be scraped clean with a knife blade or wire brush and finished off by rubbing with a gasoline soaked rag. The body can be cleaned internally by scraping and again finally wiping with a gasoline soaked rag. The electrodes can be carefully scraped clean or brushed with a wire brush.

3. The plug parts can now be re-assembled as in (Fig. 33) care being taken to see that the internal seating washer between the insulator and the body is correctly positioned and that **all joint faces are scrupulously clean**. The gland nut should then be lightly tightened on the insulator, the nose end of the insulator centralised within the body, and gland nut then finally tightened with

VILLIERS MK. 10D. & 6E. UNITS

SPARKING PLUG — CONTACT BREAKER

SPARKING PLUG—Contd.

normal effort, using a box spanner with no greater than 8" leverage.

4. The gaps can now be reset to the correct gauge and the plug is ready for re-fitting to the engine.

Note. During gap setting it is important that only the earth points should be adjusted, as any bending of the centre electrode is liable to damage the insulator.

50 IGNITION FAILURE.

In the event of ignition failure the cause will usually be found to be due to the condition of the sparking plug or contact breaker points, or faulty insulation of the plug wire or contact breaker connections.

Serious trouble in the form of condenser or coil breakdown is rare due to the great care in checking and re-checking these important parts both before and after assembly.

The first step in dealing with ignition trouble should, therefore, be to remove the plug from the engine and examine the points to see whether these are oily and the gap correctly set between .018" and .022". If the insulator is fouled with oil and carbon there may be sufficient leakage to prevent correct sparking, and cleaning will then be necessary. Fitting a new plug will readily show whether the failure is due to the plug or not.

The plug wire should then be examined for cracks or other faults.

The contact breaker can then be examined without removing the flywheel to see whether the points are opening correctly. When the points are fully open there should be a gap of .015". The surfaces must also be clean and free from oil and severe pitting. A piece of stiff paper will usually be capable of removing oil or grease. If the points are burned or pitted they should be cleaned with a fine carborundum stone if available, otherwise fine emery cloth can be used and afterwards wiped with a cloth moistened with gasoline to remove all traces of metal or emery dust.

As a result of wear of the heel of the rocker arm which bears on the cam, the point gap will be reduced. This wear should not be appreciable if the felt oiling pad is kept moist with suitable lubricant.

51 CONTACT BREAKER ADJUSTMENT.

To adjust the contact breaker the flywheel should be turned to the "points open" position. Two screws are visible in the contact breaker box, and the one with a saw slot (A) for a screwdriver is the clamp screw that holds the point plate (B) to the box itself (Fig. 34). Screw this back about half a turn with the special screwdriver spanner provided, then using this, or if preferred, a larger screwdriver, the point bracket can be levered to the correct position, using the gauge riveted to the screwdriver to get this gap correct. This gauge is .015" thick and should be a slide fit between the points when the gap is correct.

The screw should then be tightened with the screwdriver provided, this being sufficient to ensure tightness of the point bracket.

It is advisable to check the point gap after tightening.

Great accuracy of adjustment is not essential, and a variation of a few thousandths of an inch in either direction will do no harm.

52 INSULATION.

Trouble may also be caused if any metal particles become lodged between the adjustable point bracket and the body of the condenser box, thus earthing (grounding) the primary circuit.

The same effect will be caused if the insulating washer under the clamp screw or the fibre plate under the adjustable point bracket is cracked or faulty. If the contact breaker assembly has been dismantled it may be found that the insulating washer has been left out or the bush for the pivot of this bracket omitted. There is also the possibility that the insulating sleeve fitted over the wire connecting the coil to the contact breaker has been damaged.

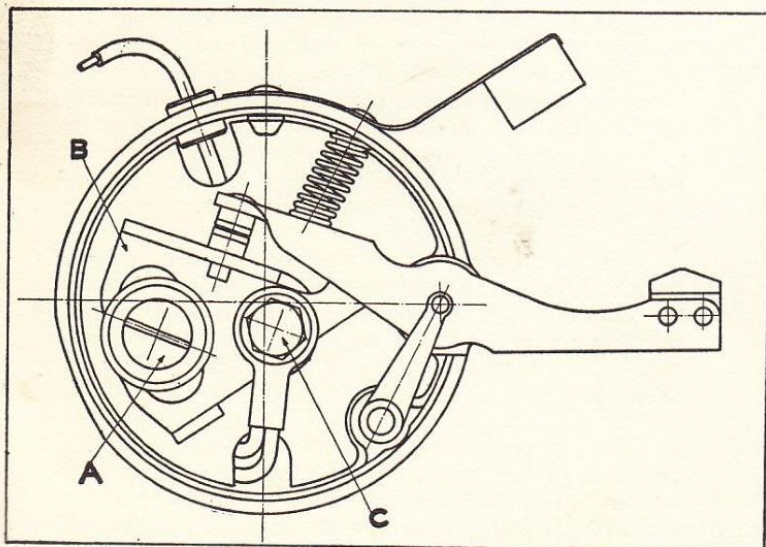

FIG. 34.

VILLIERS MK. 10 D. & 6 E. UNITS

CONTACT BREAKER — IGNITION COIL

53 SERVICING.

How to remove the magneto flywheel and instructions for re-timing have already been given under "THE ENGINE AND GEARBOX SERVICE" section.

The only parts liable to wear are the rocker arm spindle and the rocker arm pad which bears on the flywheel cam. The rocker arm is built as a complete assembly (No. 7, Fig. 32) with spindle, pad and fixed contact point, and can be withdrawn from condenser box after pushing on one side the spring clip; take care that the rocker arm spring (No. 6, Fig. 32) does not fly out.

Before the rocker arm can be withdrawn the flywheel must be removed as explained in Para 25. The contact points may become pitted after considerable mileage. This is accentuated by dirt or oil. They should be cleaned by a hone or fine emery cloth, all loose dust must afterwards be removed.

54 CONDENSER.

A condenser is fitted to the underside of the contact breaker or condenser box (No. 24, Fig. 32), and is held in position by the studs securing condenser box to armature plate. To replace the condenser the complete box must be removed from armature plate, but before this can be done the four armature plate fixing screws must be taken out to allow plate to come away from crankcase.

Undo the two nuts at the back of plate and unsolder the primary lead at the high tension coil; the box can then be removed.

Unscrew the two studs holding the condenser in position, turn the box over and remove the screw holding the lead from condenser; it will be necessary to unsolder this lead to enable same to be withdrawn through hole in box.

A faulty condenser is usually indicated by continuous and excessive sparking at the contact points, but before fitting a new condenser make sure that the studs holding the condenser are really tight to ensure a good EARTH. Occasional sparking is normal and may be ignored.

Condensers should be tested on a 200 to 250 volt direct current circuit. The reading on a micro farad meter should be between .2 and .4 micro farads. If this reading is not obtained the condenser should be discarded.

It should also be tested to ascertain that it holds the bulk of this charge for at least 15 secs. This is indicated by the sound of a good healthy spark when the tail is touched to the condenser case after this period.

It would probably function correctly if it only holds its charge for some 5 secs., but it would then be deteriorating and would cause trouble at a later date.

55 IGNITION COIL.

A fixture for testing ignition coils by the use of a 6 volt battery is shown in Fig. 35.

The coil is held in two V brackets, the primary contact at the coil end pressing on a spring strip on the base board, which is in turn connected to the point plate of the contact breaker.

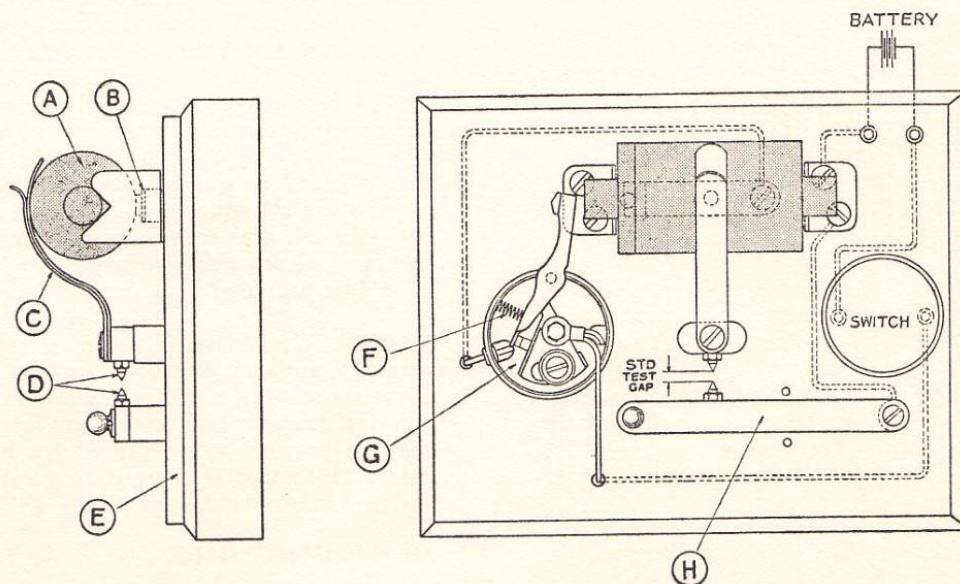

FIG. 35.

VILLIERS MK. 10D. & 6E. UNITS

IGNITION AND LIGHTING COILS

IGNITION COIL—Contd.

A swivelling arm as shown, holds the coil down by pressing on the high tension button, and takes the H.T. to the test gap.

A good servicable coil should jump 5.5 mm. at least. It should also be run on a wide gap of about half an inch even if no spark occurs on this wide gap for about two minutes. If it still sparks correctly without missing on the 5.5 mm. gap after this it should be good.

Its resistance on an ohm meter should be between 2,000 and 4,000 ohms. If below 2,000 ohms it should be scrapped, if above 4,000 it may still be serviceable, but corrosion in some form may be setting in and replacement is advisable.

It is most advisable to keep a good coil available to use as a check that the apparatus itself is functioning. The 6 volt battery may be discharged and dirt or corrosion at the contacts of the tester itself may have occurred. Also the contact breaker points of the apparatus may need renewing.

56 CHECKING OF LIGHTING COILS.

Their resistance being small—of the order of $\frac{1}{4}$ ohm—it is best to disregard the normal resistance test, as such small resistances are liable to instrument errors. It is better to use the usual "growler" test with a known good coil for comparison.

As it is rare for both coils to be defective at the same time, it is generally useful to make a comparison of the separate outputs of each coil in position.

Whilst it is unlikely that these will be identical any great difference will indicate a defective coil which can then be replaced after checking for bad contacts at the connections.

57 REPLACING IGNITION AND LIGHTING COILS.

The ignition coil is carried in coil ends which are detachable from armature plate by removing four countersunk headed screws from the back of plate.

When replacing coil see that the contact disc on outside is in the correct position to make contact with the pick-up pad when the high tension lead terminal (No. 15, Fig. 32) is screwed in.

The two lighting coils can be detached as a unit. At the right-hand side and close to the condenser box will be found a terminal screw. Release the locknuts and disconnect the lighting lead which passes through the rubber grommet in the armature plate.

Now disconnect the short leads; do not remove the insulating bushes.

The coils are fixed to armature plate by four screws at the back; remove these, and the lead from condenser box to high tension coil and lighting coils can be lifted away.

When re-fitting be careful to place connecting leads of coils so that the revolving flywheel cannot foul them.

The original coils are fixed to the armature plate and then machined concentric with the spigot to ensure that the necessary fine limits of accuracy for high efficiency are obtained. Therefore, should a fault develop with the lighting or ignition coils, it is preferable that the complete armature plate assembly should be replaced or returned to a Service Depot or Villiers Works for attention.

Where this is not possible, and Villiers replacement coils are obtained, it is necessary to ensure that the machined edge of the soft iron cores on which the lighting coils are wound, or the coil end pieces of ignition coils, are fitted so that they do not project beyond the edge of the aluminium platform of the armature plate to which they are secured, so that the clearance between them and the flywheel pole pieces is not altered.

When the flywheel and armature plate have been assembled on to the engine, the clearance should be checked by inserting a feeler gauge between the coil ends and the pole pieces on the inside rim of the flywheel. The desired clearance is .010". With this method of assembly it may be difficult to obtain the exact figures. Under no circumstances, however, should the clearance between the lighting coils or ignition coil be less than .004" at any point, as otherwise severe damage is likely to result when the flywheel is rotated or when the flywheel is distorted as a result of accident. In the case of the ignition coils the clearance should not be greater than .020". Excessive clearance will reduce the efficiency of the magneto considerably.

If it is found on assembly that the coil ends do project beyond the aluminium base, slacken off the fixing screw and give the coil ends a light tap with the handle of a hammer, afterwards thoroughly tightening screws. It should be possible to correct the clearance by this means.

Absolute cleanliness is essential when overhauling a magneto, as damp, dust or other foreign matter can easily cause short circuits. It will also be appreciated that the flywheel magnets will attract any ferrous particles which may be near to them. These are likely to cause considerable damage if allowed to remain attached to the inside of the wheel.

58 MAGNETISING.

Very powerful magnets are used, made from the highest quality magnet material obtainable. These are extremely

VILLIERS MK. 10D. & 6E. UNITS

IGNITION AND LIGHTING COILS — RECTIFIER — LIGHTING SETS

stable, and no loss of magnetism will occur during the life of the engine.

The flywheel can be detached from the armature plate without danger of affecting the magnetic strength, and there is no need to put a "keeper" over the flywheel even though this remains detached for long periods. No appreciable improvement will be obtained by re-magnetising, quite apart from the fact that very special equipment is necessary which is expensive to install.

59 CARE OF THE BATTERY.

Once a month unscrew the filler caps of each cell and pour in a small quantity of distilled water to bring the acid level with the tops of the separators. Do not use tap water as it contains impurities detrimental to the battery

Acid should not be added unless this is accidentally spilled out of the battery. This should be replaced by diluted sulphuric acid of the same specific gravity as in the cells.

Keep the battery terminals clean. Many lighting troubles can be traced to unseen corrosion between the surfaces of a perfectly tight joint and in the case of the battery this corrosion takes place much more frequently than at other electrical contacts.

The positive is earthed to reduce this effect to a minimum.

60 RECTIFIER.

This will need no attention and is practically fool proof.

It is, however, most desirable, that if the battery is taken off the machine the connections to the rectifier are also detached, as otherwise the full load of the dynamo may puncture the rectifying cells and cause failure.

In most cases no harm will result from a short period with the battery detached, but to be safe it is best to ALWAYS detach these wires if the battery is removed.

It is most important that the lead from the magneto to the rectifier should not short to earth as this will partially demagnetise the magneto if the battery is in circuit.

61 GENERAL NOTES.

It is fairly simple to check whether the rectifier, etc., is working correctly.

If the charging is in order the light will brighten when the engine is speeded up.

If the battery keeps discharging in spite of this, it is

probably defective, and should be checked over by battery repairers. It is, of course, desirable to first check that the battery terminals are not corroded or the electrolyte level below the top of the plates.

62 LIGHTING CIRCUIT.

Alternative types of lighting sets may be fitted, although the magneto unit remains unchanged. For the battery charging set the alternating current is converted by a rectifier and charges a 6 volt accumulator. The appropriate lamps are indicated below.

With this type a "STOP" light and an electric horn can be fitted. Wiring diagram is shown on Fig. 36. It will be observed that one lead is connected direct to the rectifier and a second lead (yellow) is taken to the headlamp switch. When the switch is in the "OFF" position this lead is not connected to the rectifier and a half charge is then given to the battery. When in the "H" position the switch connects this lead to the rectifier and a full charging rate obtained.

On the other type the alternating current is taken direct to the headlamp switch and a small dry battery is fitted in the headlamp shell to supply current for parking purposes. The wiring diagram is shown on Fig. 37.

63 THE HEAD LAMP. (Battery Charging Set).

Type : MU.42.

Main bulb : 6v. 24w. double filament S.B.C. (standard bayonet cap). The fitting position as indicated on the cap.

Pilot bulb : 6v. 3w. S.B.C.

64 REMOVING LAMP FRONT.

Push down the clip at the bottom of the lamp rim and pull off from the bottom. (The rim pivots on the top when opening). When replacing locate the rim top first and press on at the bottom and spring the clip into position.

The reflector is held in position by a rubber ring, remove this and the reflector can be taken out of the lamp body.

65 SETTING AND FOCUSING.

The lamp must be set to ensure that the beam is projected correctly. To obtain the best dimming light, the bulb should be correctly focused in the reflector. Adjust by slackening the screw in the clamping band and sliding the bulb holder backwards or forwards until the beam gives the best illumination on the road. Tighten the screw after making the adjustment. Note that the reflector is positioned in the lamp by a depression on the rim of the reflector fitting into a slot in the lamp body. Re-fit the rubber ring and lamp front.

VILLIERS MK. 10D. & 6E. UNITS

LIGHTING SETS

66 CLEANING.

Care must be taken when handling the reflector to prevent it from becoming finger marked. It can however, be cleaned by polishing with fine chamois leather or a clean, dry soft cloth, but even this should not be done unless the reflector is very dirty indeed. Metal polishes must **not** be used.

67 LIGHTING SWITCH.

All connections are either of the screw or spring clip type and no soldering is necessary.

68 THE REAR LAMP.

Type 477 rear lamp is fitted.

The body with bulb holder, is secured to the rear number plate by three bolts, with washers and nuts.

The bulb is a twin filament 6-7 volts, 3 watts, S.B.C. tail light, 6-7 volts, 18 watts stop light.

The cover, carrying the red and white glasses is secured to the body by a bayonet joint.

To remove the cover, twist it and then pull outwards.

To replace the cover, push and then turn it until the spring clip is heard to clip into its position.

Note that there are two wide tangs and one narrow to prevent assembling with the lighting aperture out of position. These must be mated correctly before turning the cover.

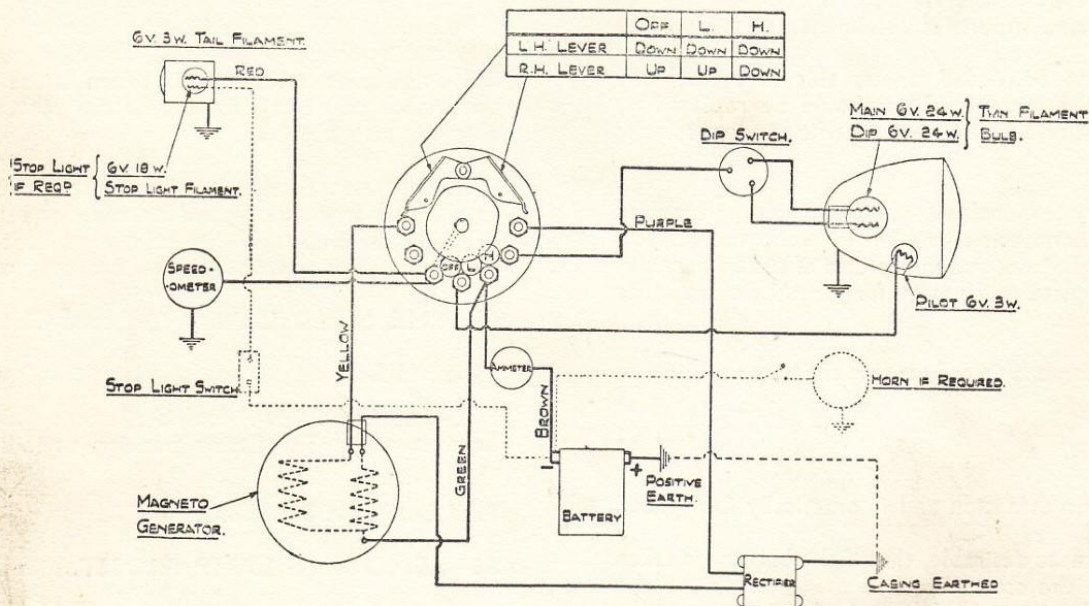

FIG. 36. WIRING DIAGRAM. "RECTIFIER" LIGHTING SET.

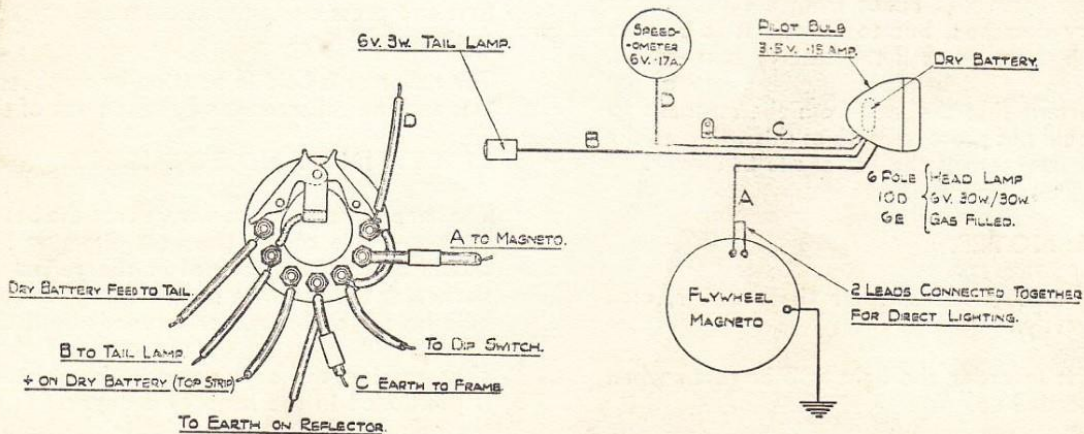

FIG. 37. WIRING DIAGRAM. "DIRECT" LIGHTING SET.

VILLIERS MK. 10D. & 6E. UNITS

LIGHTING SETS

Note also that the bulb is fitted in the correct position so that the brake switch operates the large 18 watt filament. Should this filament be on the normal tail light circuit the extra load imposed would soon discharge the battery.

A rubber cover is fitted over the sprung wire connectors.

69 THE HEAD LAMP. (Direct Lighting Set).

Type : M.35.

Main Bulb : 6v. 30w. double filament S.B.C. Fitting position is indicated on cap.

Pilot : 3.5v. 15a. M.E.S.

70 REMOVING LAMP FRONT AND REFLECTOR.

Push down the clip at the bottom of lamp rim and pull off from the bottom. (The rim pivots on the top when opening). When replacing locate the rim top first then press on at the bottom and spring clip into position.

To remove the bulb holder, turn anti-clockwise to stop and pull out.

71 SETTING AND FOCUSING.

The lamp must be set to ensure that the beam is projected correctly, and to obtain the best driving light the bulb should be set in the one of the two focus positions that appears most suitable to the user ; this is done by pushing in the bulb and turning either right hand or left hand accordingly.

The reflector can be withdrawn from the lamp front when the spring clips are sprung from their locations inside the front rim.

72 CLEANING.

As rectifier set.

73 LIGHTING SWITCH.

All connections are either of the screw or spring clip type and no soldering is necessary.

74 REAR LAMP, Type 480.

The body with bulb holder is secured to the rear number plate by three bolts with washers and nuts.

The bulb is a single filament 6-7 volts 3 watt S.B.C. The cover carrying the red and white glasses is secured to the body by a bayonet joint.

To remove the cover twist it anti-clockwise and then pull outwards. When replacing see that the parts engage properly, then turn clockwise as far as it will go. Note that there are two wide tangs and one narrow one to prevent assembling with the lighting aperture out of position. These must be engaged correctly before turning the cover. A rubber cover is fitted over the sprung wire connectors.

75 TRACING TROUBLES.

The locating and rectification of troubles with the Villiers engine can be made very simple by systematic and intelligent investigation. It is true that the symptoms of engine stoppage will usually give a clue to its cause, and that considerable experience may be needed to realise which of the number of possible eventualities has occurred, but by following a definite method of approach it is fairly easy to diagnose the cause of the trouble.

It is best to carry out tests bearing in mind that an engine will start and run satisfactorily :

- (1) If there is a supply of fuel at the carburetter, and that it is introduced into the engine with a suitable quantity of air to make a combustible mixture.
- (2) If a good spark occurs at the sparking plug in the cylinder at the correct time, that is, in these particular engines, when the piston is $\frac{5}{32}$ " before the top of its stroke.
- (3) If the engine is in mechanically good condition, that is, freedom from air leaks, has good compression both in cylinder and crankcase.

In the case of trouble, the cause of which is not evident, proceed as follows.

Work carburetter control to and fro to test that cable is not damaged, and that throttle slide is working freely. Make sure that there is fuel in tank and that the tap is turned on, depress tickler on carburetter to check that fuel has reached there and is not obstructed by a stoppage in the fuel pipe or filter in banjo union.

After assuring yourself that fuel is reaching carburetter, test for a good spark by holding sparking plug body on to cylinder head, and depressing kick starter sharply. If the spark is satisfactory, it is quite possible that the petrol-air mixture is incorrect, or that the engine is not mechanically sound. If the above quick checks fail to find the cause of the trouble, reference should be made to the charts specially prepared for the diagnosis of all kinds of troubles that can occur. See pages 38-40.

Reference has been made in the preceding pages to service tools. The complete list of tools is given on pages 41-48. Working drawings of these tools are available, and can be obtained from the VILLIERS ENGINEERING Co. Ltd., on request at a nominal charge.

FAULT FINDING CHART

ENGINE WILL NOT START		
Sequence of Testing	Possible Trouble	Remedy
<p>Check fuel supply. Depress tickler on carburetter to check whether fuel is reaching carburetter.</p> <p>If no fuel even when tap is on and fuel is in tank.</p> <p>Check ignition. Test for spark by holding sparking plug body on cylinder head.</p> <p>If still no spark: Test for spark at end of spark plug wire held $\frac{1}{8}$" from cylinder head.</p> <p>If above tests are O.K., but engine will not start.</p> <p>Check carburetter for flooding causing richness of mixture, etc., or weakness due to air leaks.</p> <p>Check over ignition timing.</p>	<p>No gasoline reaching carburetter.</p> <p>Choked fuel pipe, filter, or carburetter fuel needle sticking.</p> <p>Leak along insulation of plug or spark plug wire or high tension lead.</p> <p>Trouble may be faulty plug, oily or sooted points, slight short on insulation inside plug.</p> <p>If no spark at end of spark plug wire contact breaker points may not be opening sufficiently, or points dirty or pitted.</p> <p>Moisture on insulation of condenser box.</p> <p>Contact breaker grounded or short circuited by the points being bridged by metal particles.</p> <p>High tension pickup not making good contact on coil due to corrosion or misplacement.</p> <p>Cracked insulation of adjustable contact breaker point.</p> <p>Insulating sleeve on wires connecting contact breaker to coil or condenser damaged.</p> <p>Faulty connection to low tension wire of coil.</p> <p>Faulty condenser.</p> <p>Faulty coil.</p> <p>Mixture may be too rich due to use of strangler when engine is warm or incorrect needle setting or water in fuel.</p> <p>Air leaks at carburetter stub or joints, causing weak mixture.</p> <p>Incorrect fuel, i.e., kerosene or alcohol.</p> <p>Flywheel slipped giving incorrect ignition timing.</p>	<p>Turn on fuel tap, refill tank.</p> <p>Remove and clean out.</p> <p>Try another plug of the recommended type, and/or new spark plug wire.</p> <p>Try another plug.</p> <p>Adjust to .015".</p> <p>Clean.</p> <p>Clean and dry out.</p> <p>Remove.</p> <p>Clean or correct.</p> <p>Renew.</p> <p>Replace.</p> <p>Correct.</p> <p>Replace.</p> <p>Replace.</p> <p>Open strangler and depress kick starter several times with throttle wide open to clear engine. Adjust needle, drain and remove fuel.</p> <p>Correct.</p> <p>Fill up with correct fuel.</p> <p>Check. Timing marks on flywheel and armature plate should coincide when piston is at top of stroke.</p>

FAULT FINDING CHART

ENGINE FOUR-STROKES		
Sequence of Testing	Possible Trouble	Remedy
<p>Make sure strangler is open (Mk. 10D) and air cleaner not choked.</p> <p>Check to see if there is excessive smoking at the exhaust.</p>	<p>Too rich mixture.</p> <p>N.B. Engine may four-stroke for a little while after standing due to accumulation of oil in crankcase.</p> <p>Flooding of carburetter.</p>	<p>Try lowering jet needle by screwing down screw in centre of throttle slide (Mk. 10D) or by control lever (Mk. 6E).</p> <p>Usually ceases when engine has been running for a few minutes.</p> <p>If persistent, flooding may be due to dirt under fuel needle seating, or sticking fuel needle, or damaged seating, or punctured float in carburetter.</p>
ENGINE LACKS POWER		
Sequence of Testing.	Possible Trouble.	Remedy.
<p>Check mechanical condition.</p> <p>Examine spark plug.</p> <p>Test for compression.</p> <p>Examine engine for carbon deposit by removing cylinder head.</p> <p>Examine silencer.</p> <p>Check carburetter setting.</p> <p>Check air cleaner.</p> <p>Test brakes.</p> <p>Check fuel supply.</p> <p>Check ignition timing.</p> <p>Examine condition of piston, etc.</p>	<p>Engine out of tune, due to wear, etc.</p> <p>Unsuitable plug.</p> <p>Loss of compression.</p> <p>Incorrect mixture of oil and fuel.</p> <p>Excessive carbon deposit on piston and cylinder head.</p> <p>Exhaust system choked.</p> <p>Incorrect carburetter setting.</p> <p>Air cleaner choked.</p> <p>Brakes binding on motorcycle.</p> <p>Obstruction in fuel supply.</p> <p>Incorrect ignition timing.</p> <p>Worn or stuck piston rings.</p>	<p>Overhaul.</p> <p>Replace with recommended type.</p> <p>Check cylinder head bolt tightness. Worn piston rings.</p> <p>Use correct mixture ($\frac{1}{4}$-pt. oil to 1-gall. of gasoline)</p> <p>Decarbonise.</p> <p>Clean out silencer and exhaust pipe.</p> <p>Check with recommendations.</p> <p>Wash in gasoline, drain and re-oil.</p> <p>Adjust.</p> <p>Clean out fuel pipe and filter.</p> <p>Check and correct.</p> <p>Renew.</p>

FAULT FINDING CHART

ENGINE WILL NOT RUN SLOWLY		
Sequence of Testing.	Possible Trouble.	Remedy.
Check joints for air leaks.	Weak mixture due to air leaks at carburetter stub, crankcase, and/or cylinder base joints or name plate on left hand crankcase, drain screw missing. Crankshaft gland incorrectly assembled. Ignition timing too far advanced.	Tighten up all joints.
Check ignition timing.		Replace. Correct.
ENGINE SUDDENLY STOPS		
Sequence of Testing.	Possible Trouble.	Remedy.
Check over ignition system.	Spark plug wire disconnected. Spark plug points bridged by oil or foreign matter. Water causing short circuit of spark plug wire.	Replace. Remove spark plug from cylinder head and clean the points. Dry and remove all water.
ENGINE MISFIRES		
Sequence of Testing.	Possible Trouble.	Remedy
Check ignition.	Defective sparking plug. Loose connection in ignition circuit. Intermittent grounding of spark plug wire. Contact breaker gap insufficient. Partial stoppage in fuel supply. Fuel mixture too weak, indicated by back firing in carburetter. Water in fuel.	Try new plug. Check over all joints in wiring. Replace spark plug wire if damaged. Adjust point gap to .015". Clean out fuel pipe and filter.
Check fuel supply.		Raise throttle needle by undoing screw in top of slide (Mk. 10D) or by control lever (Mk. 6E). Drain tank and carburetter.

VILLIERS MK. 10D. & 6E. UNITS

SERVICE EQUIPMENT

Reference has been made in the preceding pages to service tools. The complete list of tools is given below. Working drawings of these tools are available, and can be obtained from the VILLIERS ENGINEERING Co. Ltd., on request at a nominal charge.

76 INSTRUCTIONS ON THE USE OF 6E AND 10D SERVICE TOOLS.

S.T.273 (6E Models). Assembly of Driving Shafts, Connecting Rod and Rollers. (Fig. No. 15).

S.T.274 (10D Models). Assembly of Driving Shafts, Connecting Rod and Rollers. (Fig. No. 15).

Procedure :

Check that the two indicator dials positioned on the side guide pillars, are set to "O," insert the one half driving shaft in the base of the sub press, see that the crankpin holder is in the top beam of the sub press, place the crankpin in same, lower the top beam and position the driving shaft radially so that the crankpin is in line with the hole in the web, place under the press and force home.

Remove the top beam and placing the con. rod over the crankpin, assemble the big end rollers in position. Add lubrication ("XL" oil).

The top beam carries three location holes on the centre line, one is for the crankpin holder, the central hole is for the driving shaft shank, and the spring plunger fitted in the third hole is for locating the second half of the driving shaft for final assembly.

Place in the central hole the shank of the driving shaft, locating the crankpin hole over the previously mentioned spring plunger.

Place the beam on its respective guide pillar, lowering same down and positioning the crankpin into the top driving shaft crankpin hole, check that the dials are at "O," and press home.

With a set of feeler gauges, determine the clearance between the driving shaft and connecting rod faces, as we require .004"/.007" side clearance deduct .005" from the feelers dimensions and set back the two dials to the figure which is shown between the feeler gauges and the .005" dimension.

Apply the second pressure to force home, finally check the clearance which should be within the previously mentioned .004"/.007".

Full details are given on the instruction plate fitted to the base of the press.

The two blocks are required due to the different stroke on the 6E and 10D models.

S.K.1793. Engine Sprocket Extractor Plate. (Fig. No. 8).

With the sprocket nut removed, attach the extractor plate to the sprocket by the two screws, in the tapped holes of the sprocket flange, use spanner on centre pin, turning in a clockwise direction, to remove sprocket.

S.T.116. Crankpin Extractor. (Fig. No. 14).

To remove the crankpin from the driving shaft assembly, place one of the shafts through the centre hole in the fixture and locate the web between the studs at the front. Secure the shaft at the back of the fixture with the nut provided. Adjust the reaction bolt until it is in contact with the balance weight.

Extract the crankpin by screwing in the tommy bar headed extractor bolt. Removing the crankpin from the other half driving shaft assembly, is done in precisely the same manner.

NOTE. Owing to the difference in the drive shaft centres, two fixtures are needed: S.T.116/1 (6E) and S.T.116/2 (10D).

S.T.120. Right Hand Driving Shaft Extractor. (Fig. 9).

To extract the right hand driving shaft from the crankcase, place the body of the extractor over the shaft and screw the four retained screws in the crankcase. Screw the extracting spindle on to the driving shaft to withdraw the shaft.

S.T.121. Left Hand Crankcase Extractor, 10D Engine. (Fig. No. 10).

S.T.242. Left Hand Crankcase Extractor, 6E Engine.

With the cylinder removed, place the slots in the plain arm over the cylinder base studs, centralise the extracting spindle on the driving shaft and screw the long retained pin into the drain plug hole, turning the extracting spindle withdraws the crankcase.

S.T.122. Clutch Locking Plate. (Fig. No. 7).

To assemble and dismantle the nut from the clutch back plate, place the locking plate over the clutch studs locating the studs in the six-cut-aways. Place the slot in the end of the locking plate over the stud in the clutch case and remove the nut with the tube wrench.

S.T.123. Engine Sprocket Locking Plate, 6E Engine. (Fig. 7).

S.T.124. Engine Sprocket Locking Plate, 10D Engine. (Fig. 7).

To assemble and dismantle the nut from the engine sprocket, place the locking plate pegs between the teeth of the sprocket, and locate the hole over the adjacent large stud. Remove the nut with a tube wrench.

VILLIERS MK. 10D. & 6E. UNITS

SERVICE EQUIPMENT

S.T.126. Final Drive Sprocket Locking Device. (Fig. 17).

To remove the nut securing the final drive sprocket, the small cheese head screw must first be removed. With the left hand place the nose of the lever into the teeth of the sprocket with the fixed end of the chain on the under-side. Wrap the chain under and around the sprocket, that is in an anti-clockwise direction, and anchor the spring into a suitable hole in the lever. Place the handle of the lever above the large crankcase stud, and unscrew the nut with a tube wrench.

To replace the nut, place the nose of the lever in a sprocket tooth and wrap the chain above and round the sprocket, that is in a clockwise direction. The lever may then be allowed to rest **under** the chain case bearing boss while tightening the nut.

S.T.139. Grinding Clutch Corks. (Fig. 25).

This is not a fixture, but a drawing giving full instruction on the grinding or turning of the clutch corks in a lathe.

S.T.140. (A. and B.) Fixture for Assembling Clutch Corks to Clutch Plates. (Fig. 26).

S.T.210.

When the corks have been thoroughly soaked in water, lead them one at a time into the appropriate fixture, making sure that they are loaded in the right position. Place the slot in the clutch plate over the top of the fixture and press the top half of the fixture down with the clutch plate until the cork is inserted into its slot. Use S.T.210 to evenly distribute the cork on each side of the plate.

S.T.243. Assembly Fixture for Fitting Bearings to Driving Shaft. (Fig. No. 23).

Place the channel between the cranks, in the case of the 10D, insert the slip block as well. Using the pressure bush, press the bearings into position.

Do not forget the distance collar on the 6E double bearing.

S.T.244. Dual Type Engine Stand. (Fig. No. 6).

This stand holds the engine in two positions, thus enabling work to be done on the magneto side. Place the clamp as shown on the illustration, *i.e.*, with the locating slot on the left-hand stud.

Place the engine with the cylinder nearest the stand, on the right-hand side, locate the crankcase mounting holes on to the small studs near the guide plates, lock the clamp with the levers provided.

To mount the engine for the magneto side turn the clamp and locate the slot on the right-hand side stud. Proceed as above but with the engine on the left-hand side of the stand.

S.T.246. Assembly Stand for Gearbox. (Fig. No. 18).

Mount the gearbox on to the stand with the drive sprocket or drive sprocket side on the left, and locate the three mounting holes on the three long studs. Position the sprocket to engage the locking plate and clamp the gearbox down with the wing nuts.

S.T.248. Mainshaft Adjuster. (Fig. No. 39).

To adjust the clutchshaft bush, place the adjuster barrel over the locking nut, and engage the legs in the slots. Loosen the nut and with the screwdriver bit inside the barrel locating in the slot in the bush, adjust the bush in or out, and retighten the nut.

S.T.251. Rivetting Block for Felt Washer Retaining Plate. (Fig. No. 38).

To rivet the felt washer retaining plate, place the four rivets into the cup holes, assemble the chaincase felt washer and retaining plate, rivet the heads over with a light hammer.

S.T.253. Special Tube Wrench. (Fig. No. 18).

This spanner may be used with S.T.126 to remove the drive sprocket nut if desired.

S.T.264. Gudgeon Pin Extractor, 10D Engine. (Fig. No. 3).

S.T.265. Gudgeon Pin Extractor, 6E Engine.

Remove the circlips from the piston and place the piston inside the extractor. Line the gudgeon pin with the hole in the extractor body and press gudgeon pin out by screwing the extractor spindle into it.

S.T.266. Ball Race Extractor Crankcases. (Fig. No. 12).

S.T.267. Support.

To extract the ball races from the crankcase halves, remove the expander from the extractor body and fit respective collet, replace in body, set the extractor by unscrewing the sleeve nut (double lever) to the end of its thread.

Place the crankcase bearing over the collet to its shoulder, and expand by tightening the small tommy bar nut.

Extract the bearing by screwing clockwise the double lever sleeve nut, to release bearing from collet, slack off expander nut $\frac{1}{4}"/\frac{1}{2}"$ and lightly tap the small tommy bar nut with hammer.

A range of collets are available for use on ball race extraction for other models of "Villiers" engines.

VILLIERS MK. 10D. & 6E. UNITS

SERVICE EQUIPMENT

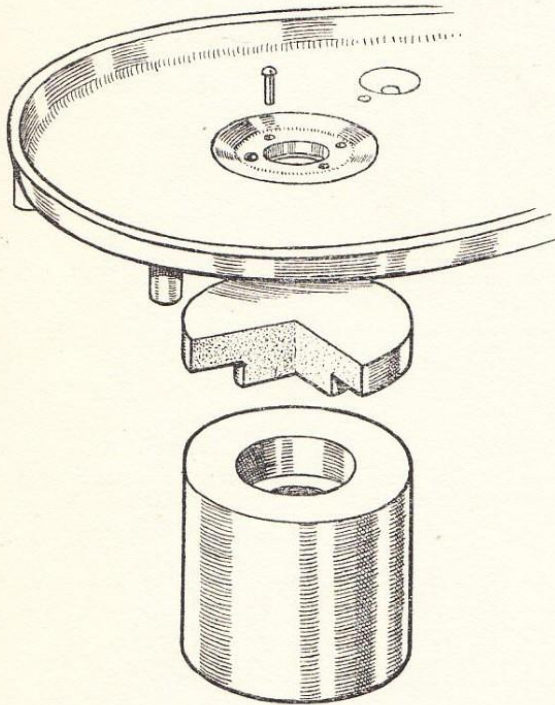

ST. 251

FIG. 38.

S.T.268. Ball Race Extractor Drive Shaft.
(Fig. No. 11).

S.T.204/B. Stand.

This tool is required, because when dismantling the crankcase, the ball races may remain on the driving shafts.

See that the ejector screw is withdrawn fully, place the drive shaft into the body with the "web" between the lugs.

Extend the locking fingers over the race by means of the knurled knobs, and press out the drive shaft by clockwise rotation of the ejector screw.

Release the ball race by withdrawing the locking fingers.

The loose centre bush is for use on 10D drive shafts. Further bushes are available for other models.

S.T.270—A, B and C (details 1 to 32 inclusive).

A.6297, S.T.310, S.T.311. Gearbox and End Cover, Bush Extraction, Refitting and Line Reaming.

S.T.270/A (details 1 to 12) is equipment for the Extraction of Gearbox and End Cover Bushes.

A base plate is provided with pillars to support both gear-

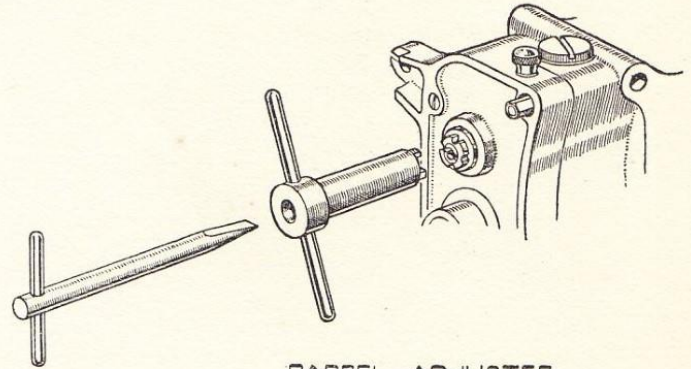

**BARREL ADJUSTER
FOR ADJUSTING BUSH & NUT
(CLUTCH SHAFT ENDPLAY)**

ST. 248

FIG. 39.

box and end cover, the drifts are individually marked for the respective extraction of layshaft, operating spindle and mainshaft bushes (Fig. No. 20).

An individual collet extractor S.T.270/11—12, is provided for the extraction of the kickstarter bush in the end cover, its operation is the same as the ball race extractor for crankcase ball bearings.

S.T.270/B (details 13 to 21). Equipment for the Insertion of Bushes in End Cover (Fig. No. 40).

The replacement bushes are loaded on to the respective guide bars, and the end cover positioned on the base S.T.270/13, see illustrations for individual position, use small hand press for inserting.

A.6297, S.T.310, S.T.311. Fixture with Adaptor for Rebushing. (Fig. No. 42).

Place the gearbox on the fixture and clamp down. Adjust the knurled spherical nut until it supports the gearbox, load the bush on to the appropriate pilot bar and using a small hand press, press the bush into position.

S.T.270/C (details 22 to 32). Line Reaming of Gearbox and End Cover Bushes. (Fig. No. 43).

Assemble the gearbox with its end cover, and clamp on the inclined face of the fixture S.T.246.

Insert pilot bush (S.T.270/26) in main bearing and retain with lock nut (S.T.270/25).

Place in pilot bars (S.T.270/24, 29 and 30) and line reamer the three bushes in end cover (the design of pilots and reamers prevent error in use), remove the pilots and guide bush, and with reamers S.T.270/31 and 32, reamer the two bushes in the gearbox.

Finally swill in "Kerosene" to remove any small particles of swarf.

VILLIERS MK. 10D. & 6E. UNITS

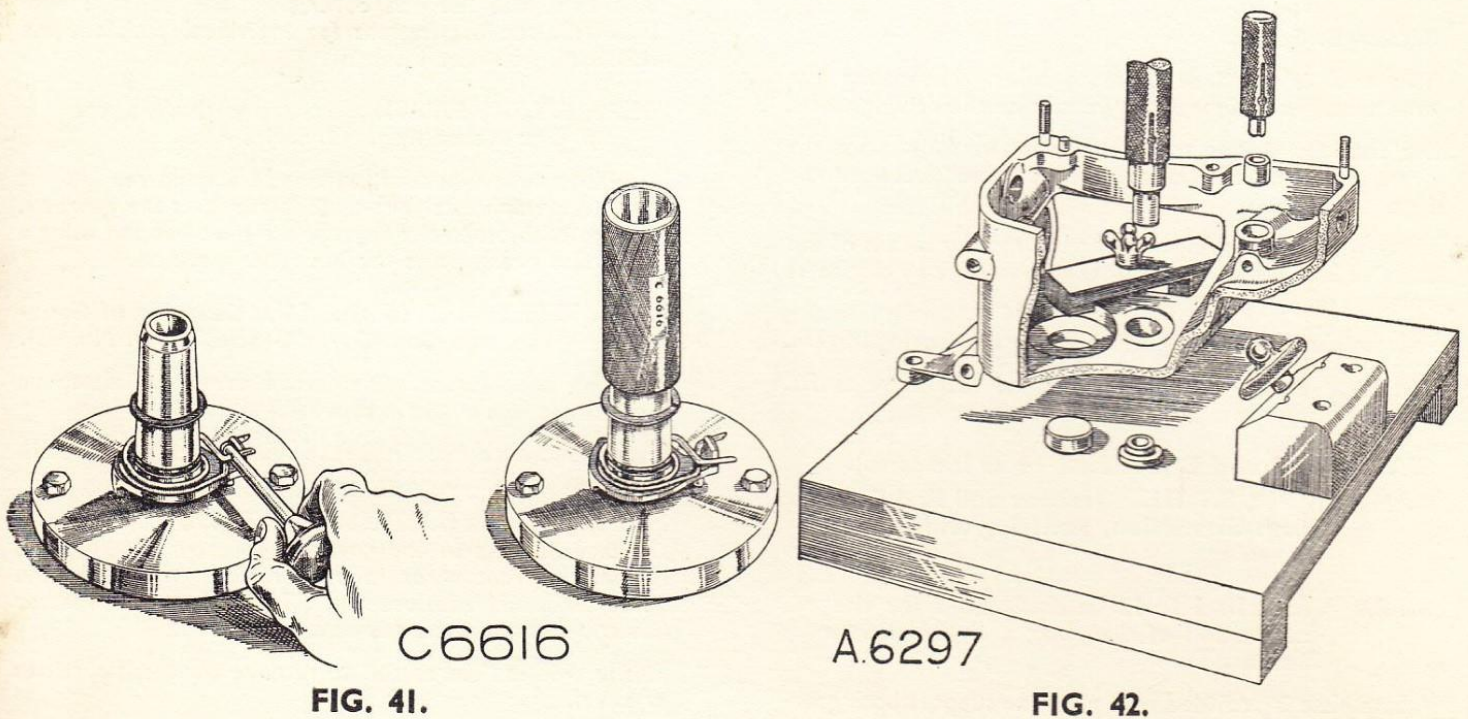
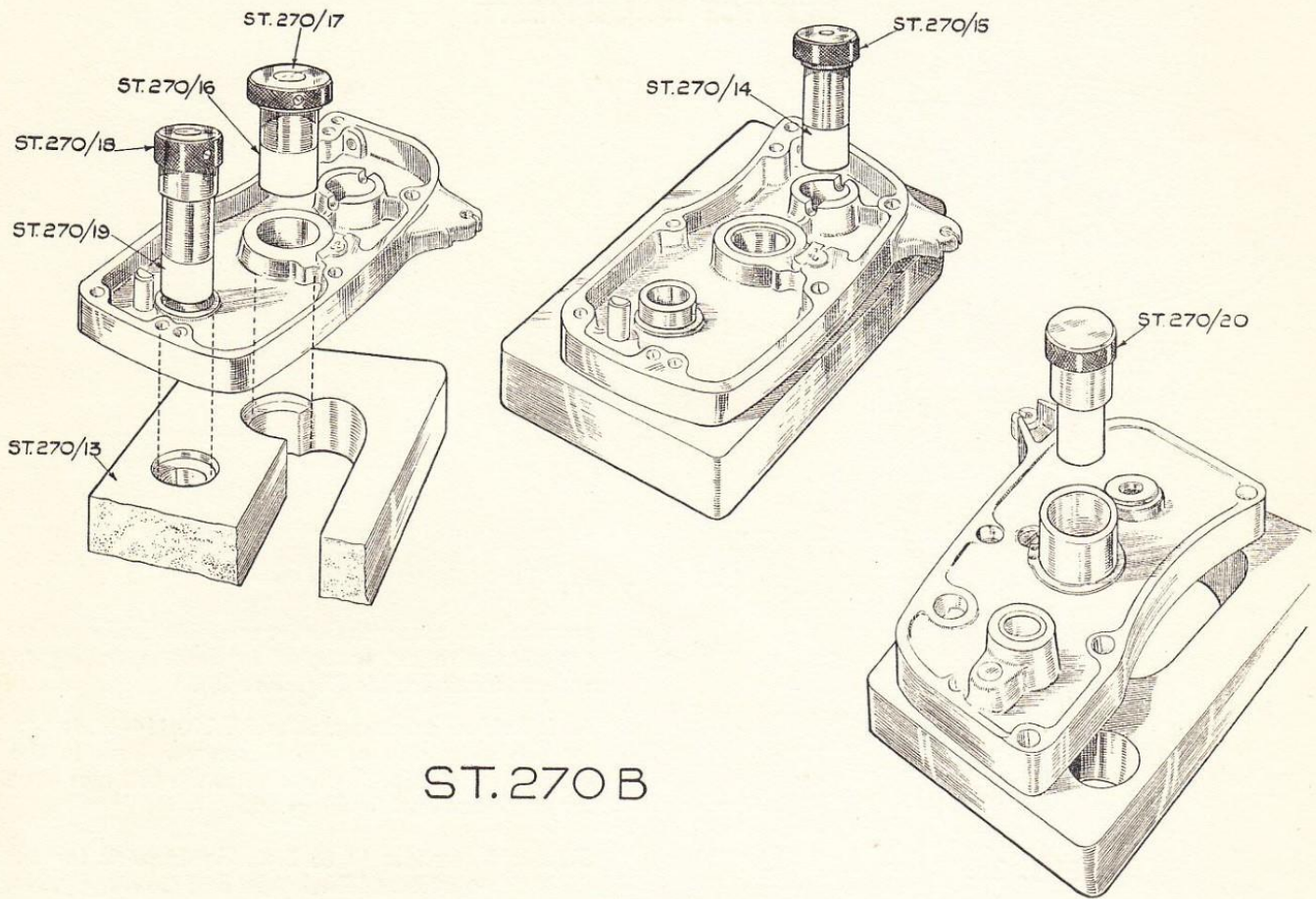

VILLIERS MK. 10D. & 6E. UNITS

SERVICE EQUIPMENT

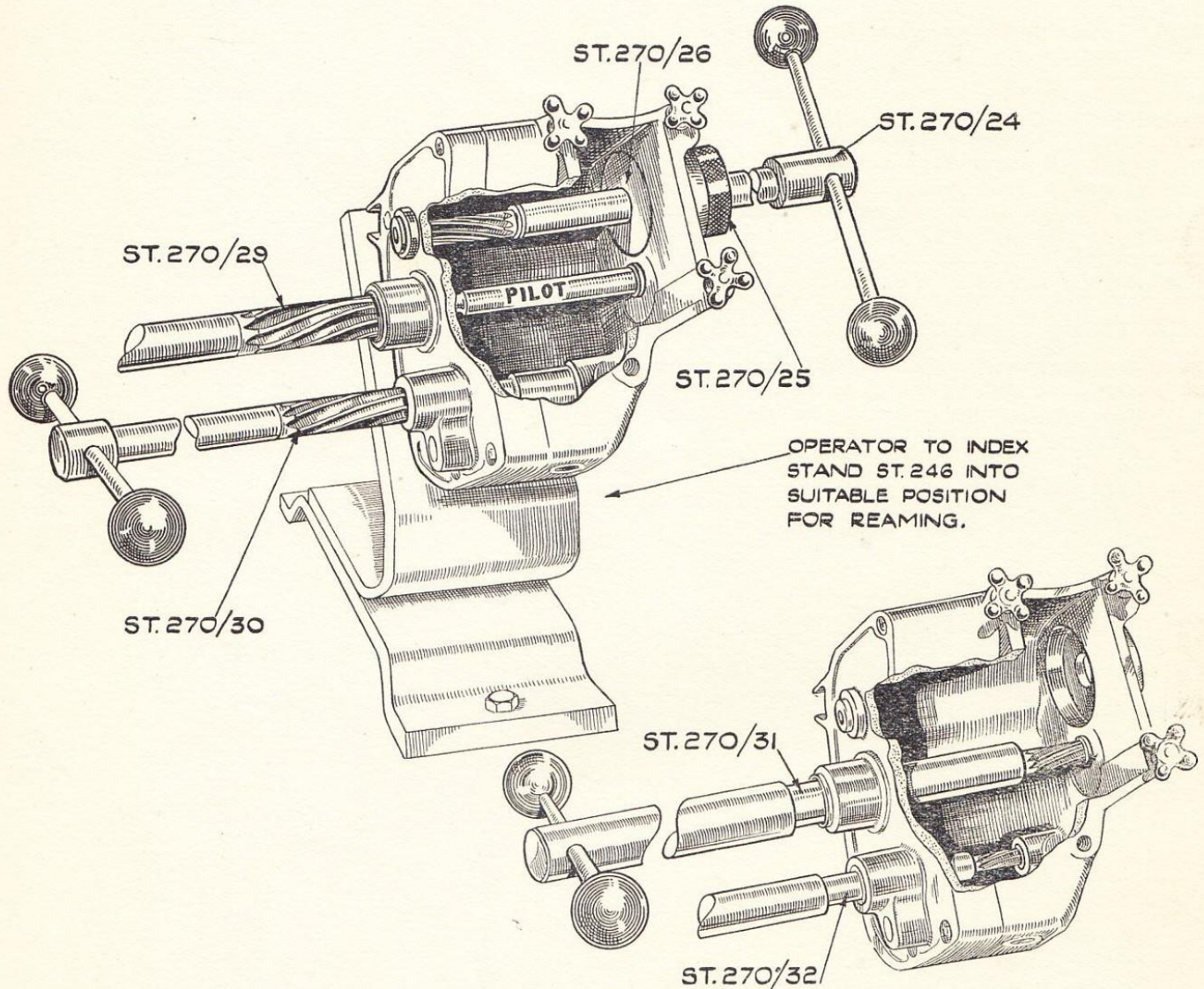

ST. 270 C

FIG. 43.

S.T.271. Ball Race Extractor Gear Case. (Fig. No. 19).

To extract ball race, place the extractor body over the bearing end and retain with the two bars through the mounting stud holes, the spring clips prevent the bars moving, screw the extracting spindle on to the ball race to remove same.

S.T.272. Assemble Fixture Driveshaft to Crankcase. (Fig. No. 22).

First read the instructions for assembling the gland bush and springs.

Heat the crankcase in boiling water for a few minutes. Place one half of the crankcase into the bore of the fixture. Place the drive shaft through the crankcase and lightly tap the bearings into position. Place the other half of the crankcase into the fixture and repeat the operations.

S.T.331. Gear Assembly Checking Fixture. (Not illustrated).

This is a dummy gearbox having windows cut in it to enable the gear parts to be fitted and examined for operations.

VILLIERS MK. 10D. & 6E. UNITS

SERVICE EQUIPMENT

C.6616. Assembly Fixture Foot Change Spring and Circlip. (Fig. No. 41).

Place the operating pawl over the spindle on the fixtures. Pick up the spring and place over the spindle position, the right-hand spring leg on to the left-hand side of the pawl, and with the small hand tool, lever the left-hand spring leg over to the right-hand side of the pawl. Place the taper piece over the spindle and position the circlip on the taper piece by hand. Pick up the plunger and place it over the taper piece. A sharp tap with the palm of the hand will now slide the circlip into position.

C.6617. Fixture to insert Core Disc. (Fig. No. 44).

Place the gearbox over the fixture with the core disc bush locating on the pillar, place the core disc in the hole and tap home with the punch using a lightweight hammer.

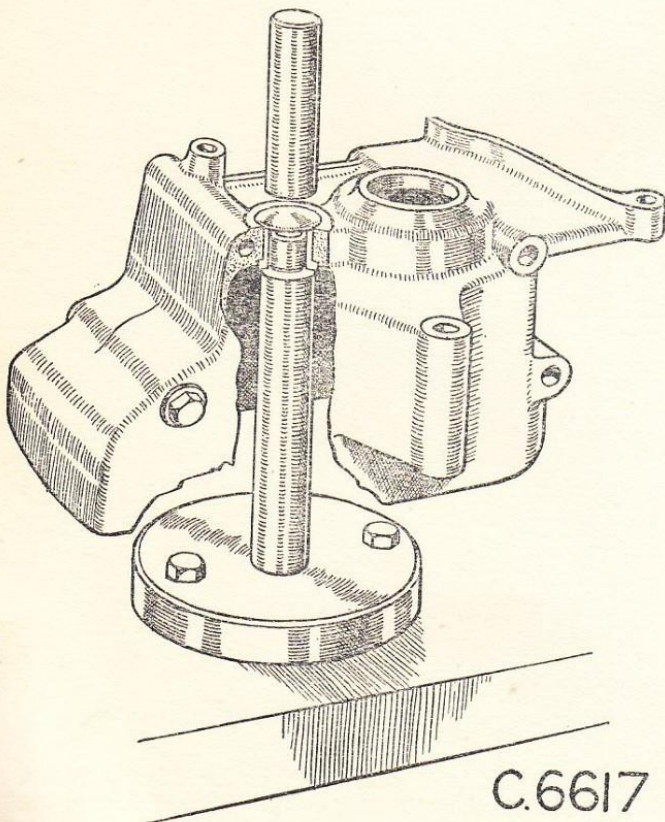

C.6617

FIG. 44.

B.6618. Assembly Fixture for Bearing in Gearbox. (Fig. No. 45).

Place the gearbox on to the fixture, locating the bearing housing over the large spindle and the smaller bush over the locating bung. Place the ball race over the large pillar and press it into the housing with the pressure bush, under a small hand press.

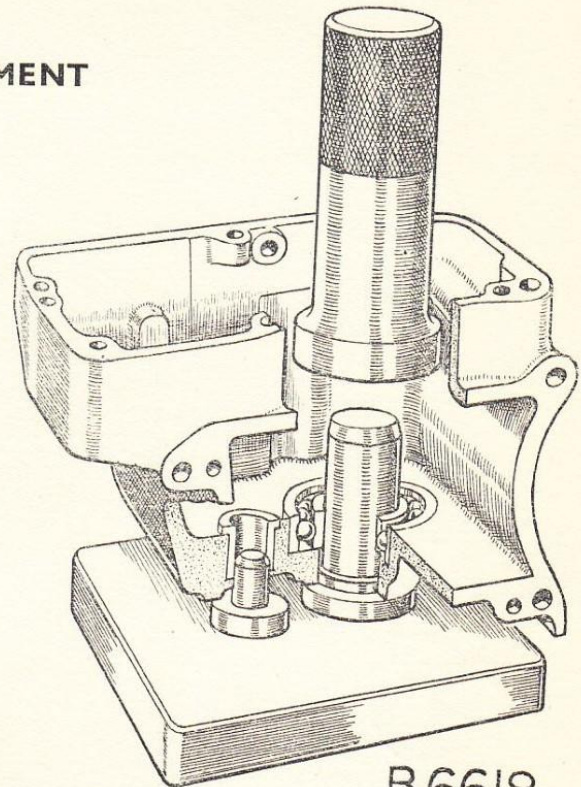

B.6618

FIG. 45.

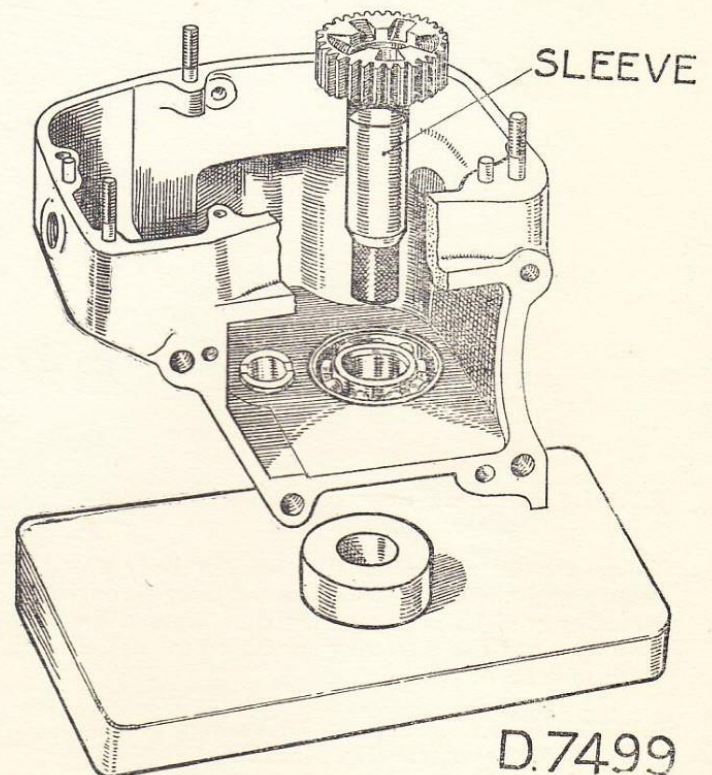

D.7499

FIG. 46.

VILLIERS MK. 10D. & 6E. UNITS

SERVICE EQUIPMENT

D.7499. Adaptor Bush for fitting High Gear Wheel.
(Fig. No. 46).

This is the guide piece referred to in the manual, and should be used as instructed there, do not forget the bearing sealing washer in between the gear face and bearing.

S.T.316 (Detail 2 to 8). Carburettor Body and Control, Gauges and Equipment.
(Fig. No. 47).

Assembly stand S.T.316/2 (10D model), S.T.316/3 (6E model), is for use on carburettor body for "seating" fuel needles, and to drive in the "fuel needle" lever pin.

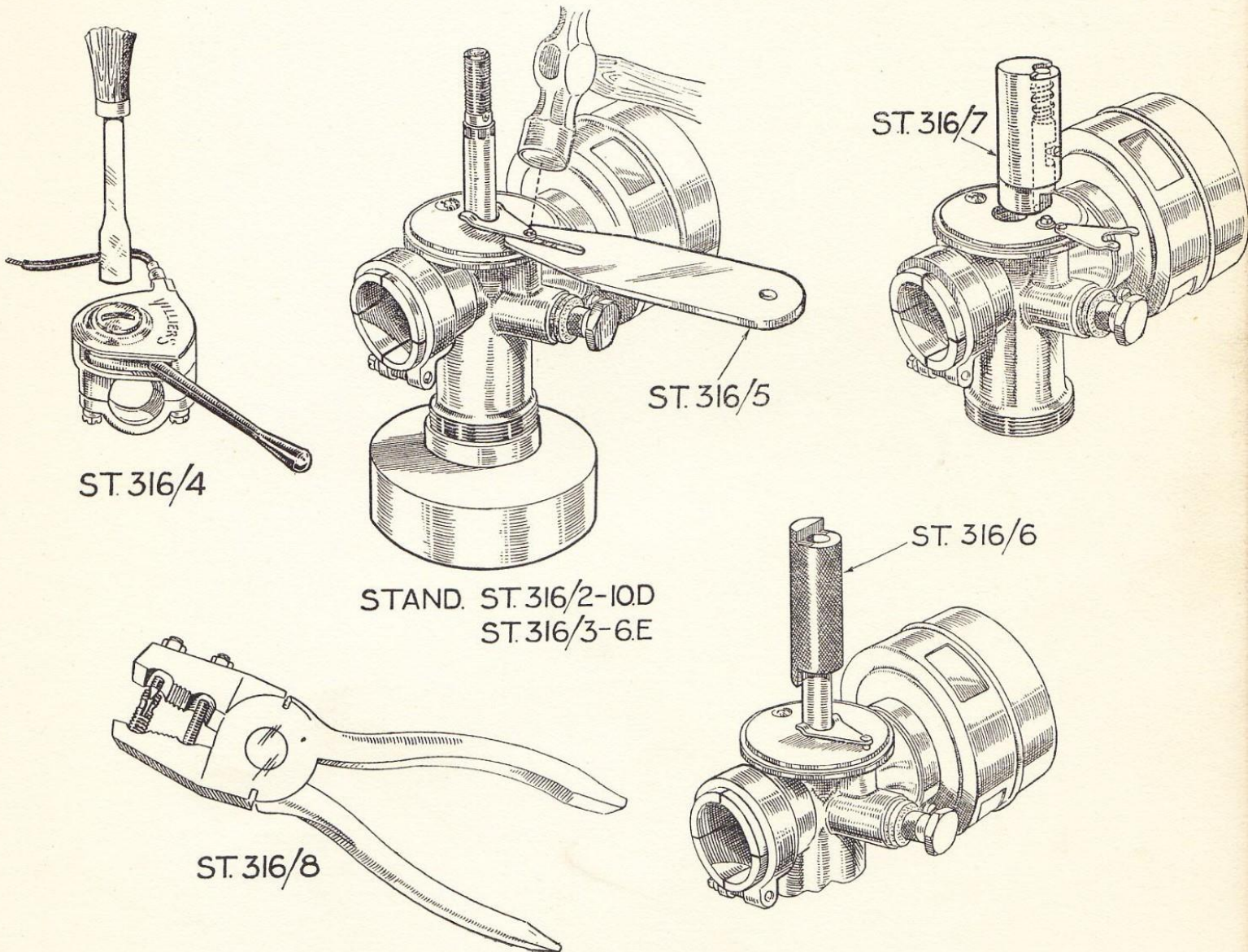

ST.316

FIG. 47.

VILLIERS MK. 10D. & 6E. UNITS

SERVICE EQUIPMENT

The respective positions of these two components are obtained by using gauges S.T.316/7, for the fuel needle, and S.T.316/5 for the fuel needle lever pin.

With the "centre piece" in position, the gauge S.T.316/6 is used to obtain the working position of "Float" contact face of the fuel needle lever.

The modified "pliers" (S.T.316/8) are for "springing" open the slot in the needle adjuster screw to give friction in the throttle threads on assembly.

S.T.316/4. A special shape screw driver is for use on the "control cover screw" when assembly after replacement of cable, lever, etc.

Carburettor Compensating Tube. (Not illustrated).

A special "tubular key wrench" is available to prevent damage in fitting and dismantling.

Large type (Drg. No. S.T.298/1) for all carburettors marked 5/—

Small type (Drg. No. S.T.298/2) for other models.

NOTES

VILLIERS MK. 10D. & 6E. UNITS

NOTES

VILLIERS MK. 10D. & 6E. UNITS

NOTES

VILLIERS MK. 10D. & 6E. UNITS

INDEX

CARBURETTER.

	Para.	Page
Centre Piece Removal	37	27
Dismantling	36	27
Float Chamber Removal	37	27
Fuel Needle Removal	37	27
Needle Adjustment	41 & 42	27
Operation	34	25
Re-assembly	40	27
Tickler Removal	38	27
Tuning Hints	43	27
Type	33	25

CONTROLS.

Clutch Control Adjustment	6	5
Gear Control Assembly	31	20
Starting	7	5
Data	—	2 & 3

ENGINE.

Ball Bearings	29	19
Clutch Re-assembly	32	21
Clutch Re-corking	—	22 & 23
Cylinder Barrel Honing	15	7
Cylinder Barrel Re-boring	14	7
Cylinder Barrel Re-boring Sizes	16	7
Cylinder Barrel Re-fitting	17	8
Cylinder Barrel Removal	12	6
Cylinder Head Removal	10	6
Cylinder Head Re-fitting	11 & 18	6 & 8
Decarbonising	9	6
Dismantling	25 & 27	13 & 16
Driving Shaft Assembly	26	16
Driving Shaft Dismantling	26	14
Driving Shaft Re-assembly	26	14
Engine Re-assembly	30 & 32	19 & 21
Foot Change Assembly	28	17
Gear Assembly	31	20
Kick Starter Shaft Re-assembly	31	21
Magneto Removal	25	13
Magneto Contact Breaker	51	32
Piston Removal	13	6
Periodical Attention	6	5
Piston Ring Gap	17	8
Starting	7 & 8	5 & 6

FAULT FINDING CHART.

	Para.	Page
Fault Finding Chart	—	38/40

LIGHTING.

Circuit, Diagrams	—	36
Coils—Replacing	57	34
Coils—Testing	56	33
Headlamp (Battery Lighting)	63	35
Headlamp (Direct Lighting)	69	35
Rectifier	60	34
General Notes	61	34

LUBRICATION.

Contact Breaker Cam.	47	30
Engine	Data & 4	3 & 5
Gearcase	Data & 4	3 & 5
Recommended Lubricants	4	5

MAGNETO

Condenser Removal	54	32
Condenser Testing	54	32
Contact Breaker	47	30
Contact Breaker Adjustment	51	32
Contact Breaker Insulation	52	32
Ignition Coil Replacing	57	34
Ignition Coil Testing	55	33
Magnetising	58	34
Operation	46	29

SPARKING PLUG.

Sparking Plug	49	31
Sparking Plug Cleaning	49	31

INDEX

17
18
19
20
21
22
23
24
25
26
27
28
29
30
31
32
33
34
35
36
37
38
39
40
41
42
43
44
45
46
47
48
49
50
51
52
53
54
55
56
57
58
59
60
61
62
63
64
65
66
67
68
69
70
71
72
73
74
75
76
77
78
79
80
81
82
83
84
85
86
87
88
89
90
91
92
93
94
95
96
97
98
99
100

