

From December 12th, 1955, until further notice,  
all prices in this list are increased by 20%

OCTOBER, 1954

**Villiers**

THE  
EXPERIENCE  
BEHIND  
KEEPS VILLIERS

**OPERATING INSTRUCTIONS  
AND  
SPARE PARTS LIST**

**CANCELLED**  
FROM FEB. 1955 UNTIL FURTHER  
NOTICE ALL PRICES IN THIS LIST  
ARE INCREASED BY 5%

**1/-**  
**CANCELLED**  
IN FRONT....  
TWO SHILLINGS



ENGINE

**THE VILLIERS ENGINEERING CO. LTD.  
WOLVERHAMPTON, ENGLAND**

VEC. 80.

## Introduction



**Y**OUR Villiers engine is the heart of the machine in which it is installed. It has been manufactured and assembled with great care and precision, and it will give you long and efficient service if it receives the attention it deserves.

This book contains the necessary information to enable you to give your engine this simple, but important routine attention, and you will be well advised to keep the book on hand for consultation when necessary.

After a long period of service, your engine may require overhauling, and it is important always to make sure that only genuine Villiers replacement parts are used. Remember that genuine Villiers spares are made with the same fine workmanship as the original engine components.

### **THE VILLIERS ENGINEERING COMPANY LTD.**

**Marston Road**

- - -

**Wolverhampton**

TELEPHONE:—  
WOLVERHAMPTON  
22399 (20 LINES)

TELEGRAMS:—VILLIERS,  
WOLVERHAMPTON.  
CODE:—BENTLEY'S.

THE

*Villiers*

MARK

**4F**

TWO-STROKE  
MOTOR CYCLE

**ENGINE**

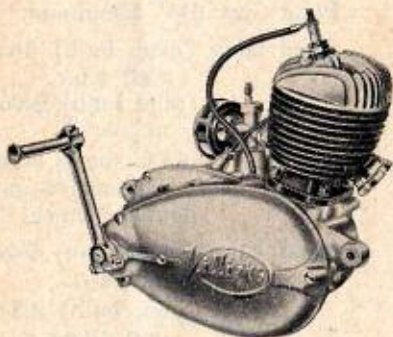

**BEFORE ATTEMPTING TO START THE ENGINE,  
CAREFULLY READ PAGES 4, 5 and 6.**

Index - - See page 36.

## GENERAL DATA.

Engine Unit	...	...	Model Mark 4F.
Bore	...	...	47 mm. = 1.8504 inches.
Stroke	...	...	57 mm. = 2.244 inches.
Capacity	...	...	98 cc. = 6 cubic inches.
Horse Power, Maximum	...	...	2.8 at 4,000 r.p.m.
Engine Sprocket	...	...	17 Teeth, $\frac{3}{8}$ inch Pitch.
Clutch Sprocket	...	...	42 " " " "
Ratio, Engine to Clutch	...	...	2.47—1.
Gear Box Ratios	...	...	1.64—1 and 1—1.
Final Drive Sprocket	...	...	14 Teeth, $\frac{1}{2}$ inch Pitch for " COVENTRY " Chain No. 112045.
Chain Line, Final Drive	...	...	2.56 inches.
Final Gear Ratios	...	...	Top 8.47—1, bottom 13.89—1 with rear wheel sprocket having 48 teeth, and tyre size 25 inches.
Exhaust Pipe	...	...	1 $\frac{1}{2}$ inch external diameter.
Sparking Plug	...	...	14 mm. Lodge H14, Point Gap .018" to .025".
Carburetter	...	...	Villiers " Junior " type 6/0.
Carburetter Jet Size	...	...	No. J.120.
Carburetter Taper Needle	...	...	No. 2 $\frac{1}{2}$ Type 6/0.
Ignition Timing	...	...	$\frac{1}{8}$ " before top dead centre.
Contact Breaker	...	...	Point Gap .015" Maximum.
Lighting Set (Rectifier)	...	...	Head lamp (main bulb) 6-volt 12/12 watt s.b.c. (pilot bulb) 6-volt 3 watt m.b.c. Tail lamp (main filament) 6-volt 3 watt. (stop filament) 6-volt 18 watt double filament s.b.c.
Lighting Set (Direct)	...	...	Head lamp (main bulb) 6-volt 24/24 watt D/C. (pilot bulb) 3.5-volt 0.15 amp. m.e.s. Tail lamp 6-volt 3 watt s.c.
Lubrication, Engine	...	...	Petrol mixture in fuel tank 1 part Castrol XL Oil (S.A.E. 30) to 20 parts petrol.
Lubrication, Gearbox and Chaincase	...	...	Castrol "D" Oil (S.A.E. 140) filled to level plug. (See Fig. 1).
Weight	...	...	38 lbs.

## SPECIFICATION.

The Villiers Mark 4F. Unit consists of a 98 c.c. two-stroke engine and two-speed gearbox built as one assembly. The drive from the engine crankshaft to the clutch on the main shaft of the gearbox is by means of an endless roller type chain running in an oil bath case.

**Crankcase and Gearbox.** This is an aluminium casting in three main parts, enclosing the two-speed gearbox and flywheel magneto. A detachable cover on the left hand side of the engine encloses the contact breaker mechanism, which for ease of maintenance is located on the crankcase on the opposite side to the flywheel magneto.

**Cylinder.** A deeply finned cast iron cylinder is used, having one inlet, one exhaust, and two transfer ports. The cylinder is secured to the crankcase by four studs.

**Cylinder Head.** Secured to the cylinder by four bolts, the detachable aluminium alloy cylinder head is fitted with a Lodge type H14 14 mm. thread sparking plug.

**Piston and Connecting Rod.** The aluminium flat-topped piston carries two compression rings, and a special expander ring is fitted inside the lower ring to ensure proper compression when the engine is started from cold.

A floating gudgeon pin is fitted, and is located endwise by circlips. The connecting rod is a steel forging, having a plain bronze bearing at its small end, and at its big end, two rows of steel rollers running on the crankpin.

**Crankshaft.** This is a steel forging in two parts, rigidly joined together by the fitting of the crankpin. At each side, the crankshaft is carried in a large ball-bearing which ensures free running and minimum wear. The contact-breaker cam is formed on the end of the left-hand half of the crankshaft.

**Carburetter.** A Villiers Junior pattern carburetter is fitted at the rear of the cylinder, being mounted on a stub which is cast integral with the cylinder barrel. Control of the carburetter is by a hand lever or twist grip. A combined air filter and strangler is standard equipment. This is placed within convenient reach of the rider, and ensures easy starting.

**Clutch.** The two-plate clutch has cork inserts, and is controlled by means of a Bowden cable attached to a lever fitted on the handlebar of the machine.

**Two Speed Gear.** The two gears are engaged by means of a sliding dog mechanism, there being a neutral or "free engine" position between high and low gears. Control is by a Bowden cable and a lever on the handlebar.

**Kickstarter.** A kickstarter is provided as an integral part of the gearbox, the kickstart lever being fitted with a pedal which folds out of the way when not in use.

**Final Drive.** This is taken to the rear wheel from a sprocket on the left hand side of the engine, by means of a roller type chain.

**Magneto.** As with all Villiers engines, current for ignition and lighting is provided by the flywheel magneto. On this model a special type has been developed, having a separate contact breaker mounted on the left hand side of the crankcase, and operated by a cam on the end of the crankshaft.

## RUNNING THE ENGINE.

### BEFORE STARTING FOR THE FIRST TIME.

**Gearbox.** Remove the gearbox oil filler and oil level plugs (see Fig. 1.) With the motor-cycle off the stand, pour in CASTROL "D" oil (SAE 140) until it starts to run out at the hole from which the oil level plug has been removed. Screw both plugs firmly back into position.

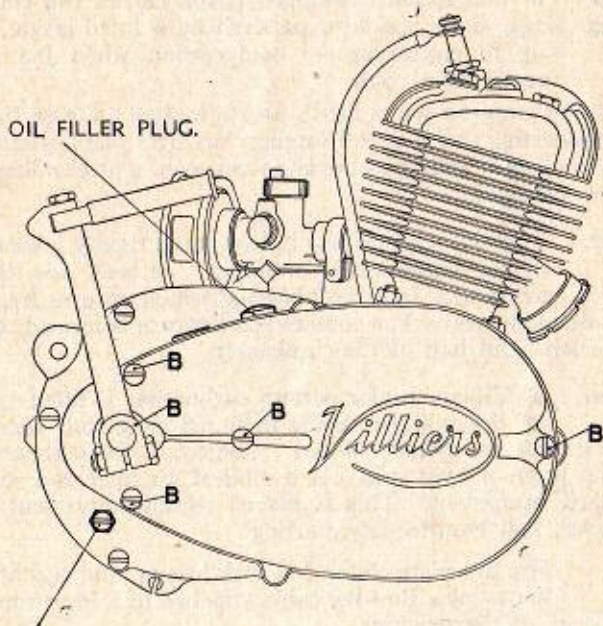

OIL LEVEL PLUG.

Fig. 1.—Mark 4F engine, right-hand side.

(Remove items marked "B" for access to flywheel).

**Fuel Tank.** Fill up the fuel tank of the machine with "petrol" mixture. This is made by thoroughly mixing one part of CASTROL "XL" oil (SAE 30) with 20 parts of petrol. It is best to pour the petrol mixture into the tank through a fine mesh gauze or strainer, to make sure that no dirt or grit gets into the engine.

ON NO ACCOUNT must the oil be put into the fuel tank before mixing with the petrol. If this is done the oil and petrol will not mix, the engine will not be properly lubricated, and the operation of the carburetter will be affected.

**Gear Control.** The two-speed gearbox is controlled through a Bowden cable, by a hand-operated gear-lever which is clipped to the right-hand handlebar. Three positions are marked on the cover plate of the gear-lever; LOW for bottom gear; N, which is the neutral or free engine position; and HIGH for top gear.

Put the gear-lever into the neutral position. This operation is sometimes made easier if the motor-cycle is moved backwards and forwards at the same time.

When changing from high to low gear, it is only necessary to push the lever to the right with the thumb.

Changing to high gear is done by pulling the lever to the left.

When driving the motor-cycle, it is necessary to take a certain amount of care in changing gear in order to obtain smooth and steady running. See under "On the road" on page 6.

## STARTING THE ENGINE.

First of all make sure that the battery is connected. If the battery is not in use, the rectifier must be disconnected.

**When the Engine is Cold.** Turn the petrol tap to the ON position.  
Close the strangler shutter on the air filter.  
Open the throttle lever inwards one third of the full movement, then flood the carburetter by pressing the tickler.

A firm push or two on the kickstarter pedal should start the engine, and as it warms up the strangler shutter on the air filter should be gradually moved round to its fully open position.

In very cold weather it may not be possible to do this immediately, in which case leave the strangler shutter partly closed until the engine is thoroughly warmed up.

**When the Engine is Hot.** Follow the same procedure as given above, but do not flood the carburetter or close the strangler.

**Failure to Start.** If the engine will not start after a reasonable number of attempts, the cause of the trouble may be found by a systematic check-over as given under the heading "Tracing Troubles" on page 16. Read this section carefully before doing anything to the engine.

## ON THE ROAD.

Having started and warmed up the engine, sit astride the motor-cycle, and with both feet on the ground free the clutch by pulling up the clutch control lever, which is usually fitted on the left handle-bar. At the same time, with the right thumb push the gear-lever outwards to the low gear position.

NOTE:-When engaging bottom gear with the machine stationary, any tendency of the driving parts to "snatch" will be much reduced if the clutch lever is pulled right up, and the engine is kept down to a slow tick-over speed.

Slowly release the clutch lever, and as the motor-cycle moves forward under its own power, open the throttle to prevent the engine stalling whilst taking up the drive through the clutch.

When a speed of about 12 miles an hour has been reached, HIGH gear should be engaged. Free the clutch as before, and at the same time almost close the throttle; then while the clutch is disengaged move the gear-lever smartly inwards to the HIGH position. As soon as high gear has been engaged, release the clutch lever and open the throttle. To change down to LOW gear, disengage the clutch and regulate the throttle control to give an increase in engine speed, in step with the low gear ratio, then smartly move the lever into "LOW" position.

Do not "hang on" to top gear too long when climbing a hill; make full use of the lower gear, which is provided for this purpose.

Never control the road speed by disengaging the clutch just enough to let it slip. This should only be done when travelling very slowly in traffic, otherwise great wear of the clutch surfaces will take place, and eventually the clutch will slip at all times.

## RUNNING-IN.

For the first 500 miles the engine must not be over-driven, and during this period the throttle should never be fully opened. The engine must not be allowed to race, or run at a high speed under a light load. Until the first 500 miles have been run, do not exceed the following speeds:—

LOW gear	...	12 miles per hour.
HIGH gear	...	20 miles per hour.

After covering the first 500 miles the road speed can be gradually increased, but when climbing a hill change to the low gear before allowing the engine to labour and become overloaded.

In short, "nurse" the engine carefully for this initial period, and such care will be amply repaid afterwards in terms of longer life and better performance from the engine.

It is very likely that when the running-in period has been completed, it will be necessary to weaken off the mixture of fuel and air passed by the carburetter to the engine. This is done by slightly lowering the taper needle in the carburetter. The method of doing this is given in the section on the carburetter, on page 12.



## ROUTINE ATTENTION.

Every engine needs a certain amount of attention at regular intervals if it is to give trouble-free service. If the following points are given proper attention, the engine can be expected to maintain its reputation for reliability and economy, while at the same time, very little will be needed in the way of replacement parts.

**After the First 500 Miles.** Examine the contact breaker points. Access to these is obtained by removing the three screws marked "A" on Fig. 2, and the cover they secure. The points may require slight adjustment after their initial "bedding-in," and for this refer to page 9.

**Every 500 Miles.** Inspect the level of the oil in the gearbox casing by removing the oil level screw as shown in Fig. 1 (page 4). If necessary, top up with the grade of oil recommended on page 4.

**Every 2,000 Miles.** Remove the cylinder head and scrape out the carbon deposit which collects inside. Take care not to remove any metal. The edges of the exhaust port in the cylinder can be cleaned when the piston is at the bottom of the stroke. Clean the top of the piston. Remove and clean the silencer and exhaust pipe.

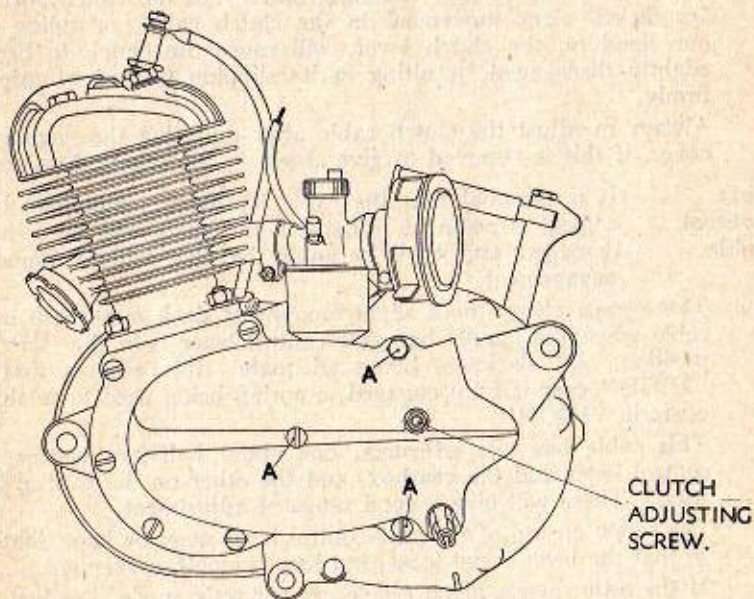

Fig. 2.—Mark 4F engine, left-hand side.  
(Remove screws marked "A" for access to contact-breaker).

**Every 4,000 Miles.** Take off the air cleaner and wash it in petrol, allowing it to dry afterwards. Then dip it into thin oil and let most of this drain off before replacing the air cleaner.

At this stage it may be necessary to remove and inspect the cylinder and piston, giving these parts a thorough cleaning. This should not be done, however, unless there is a good reason for it.

**Occasionally.** Examine all joints between parts for gas or oil leaks, and tighten the securing bolts or screws if necessary. This applies particularly to the joints between the cylinder head and cylinder barrel, crankcase and cylinder barrel, and the crankcase parts themselves. All visible nuts, bolts and screws should be checked and firmly tightened if need be.

### **CLUTCH AND GEAR CONTROL CABLE ADJUSTMENT.**

It is very important that these two cables are kept properly adjusted, thereby preventing increased wear and tear and possible damage to internal parts.

**Clutch Control Cable.** There should be a very small amount of slack in this cable when the clutch is engaged; about  $\frac{1}{8}$ " to  $\frac{1}{4}$ " is sufficient. The cable is adjusted by means of the screw shown in Fig. 2. (page 7). Screw this in or out until the required amount of slack is obtained, and tighten the locknut afterwards. When the engine is new, fairly frequent adjustments may be necessary owing to the "bedding down" of the clutch surfaces. Insufficient slack movement in the clutch cable, or riding with one hand on the clutch lever, will cause the clutch to become slightly disengaged, resulting in its slipping instead of gripping firmly.

Always re-adjust the clutch cable after replacing the engine side cover, if this is removed to give access to the contact-breaker.

**Gear Control Cable.** It is essential that the cable is always maintained in its correct adjustment, otherwise the gears will be seriously damaged, and it will be found that they will not remain in engagement.

There must always be a slight amount of slack movement in the cable when the handle bar gear control lever is in the "HIGH" position,  $\frac{1}{8}$ " slackness being adequate; this ensures that the "HIGH" gear is fully engaged, a spring being used to retain the gears in "HIGH."

This cable has two adjusters, one about half-way between the control lever and the gearbox, and the other on the control lever itself. These will give a good range of adjustment.

The screw on top of the gear control lever must be kept tightened so that the lever is not loose, but has a smooth movement.

If the adjustments given above are correctly made, but low gear still jumps out of engagement, this indicates that the engine has been running with incorrect cable adjustments, thus damaging the gears.

## IGNITION ADJUSTMENT AND TIMING.

**Contact Breaker Adjustment.** The contact breaker assembly, Fig. 3 (page 10), and condenser are secured to the left-hand side of the crankcase, underneath the detachable cover. The contact breaker points may require adjustments at intervals, although this should not be done unless it is definitely necessary. Turn the crankshaft until the moving point is in its highest position. With a feeler gauge, check the clearance between the two points, which should be .015".

If it is either more or less than this figure, slacken the screw "A" shown on Fig. 3, and move the bracket "B" in the required direction to obtain the correct clearance.

Re-tighten the securing screw firmly.

Check the clearance once more to make sure that the bracket did not move when the screw was tightened.

**NOTE:** The feeler gauge should be a sliding fit between the contact breaker points. Never adjust the points so that the gauge is a tight fit; if this is done, proper clearance will not be obtained. When replacing the side cover, check that the clutch operating lever is replaced correctly, and that the clutch cable has the correct amount of slack (see page 8).

**Ignition Timing.** The contact breaker points should commence to open when the piston is  $\frac{1}{8}$ " before the top of its stroke.

To check the timing, remove the cover on the left-hand side of the engine to expose the contact-breaker mechanism, and also remove the sparking plug so that the top of the piston can be seen when setting it in its correct position.

After setting the piston, examine the contact-breaker points, which should just be commencing to open. If they have not done so, or have opened fully, the timing is wrong. Correct as follows:—Slacken the three screws "C" Fig. 3, which secure the complete contact breaker assembly to the crankcase, and move the assembly to the left or right according to the adjustment required.

Turning the contact-breaker plate to the right, or clockwise, will advance the ignition timing, and turning to the left, or anti-clockwise, will retard the timing.

When satisfied with the adjustment, re-tighten screws "C."

**NOTE:** Always set the contact-breaker points to their correct gap of .015" before timing the magneto.

## DISMANTLING THE ENGINE.

**Dismantling.** No reference has been made in these instructions to complete dismantling of the engine, beyond that necessary for decarbonising. This is because special equipment is needed for dealing with the lower half of the engine, gearbox, etc.

If anything has gone amiss with any of these parts, rather than attempt to take the engine completely to pieces without the proper tools, it will be far better to entrust the work to the dealer from whom the motor-cycle was purchased. Alternatively, the complete engine can be returned to Villiers service department for the most expert attention.

**Re-assembly.** If for any reason the lower half of the engine has been dismantled, it is **ESSENTIAL** that the clutch spring retaining nut is correctly re-assembled so that the clutch shaft itself has an adequate amount of "end float." If this is not done, replacements will soon be necessary in the gearbox.

The clutch spring retaining nut should therefore be adjusted so that the effective width of the clutch assembly is between 3.665" and 3.680". This width is measured between the outer end of the large splines at the left-hand end of the clutch shaft, and the outer face of the lockwasher securing the nut at the other end.

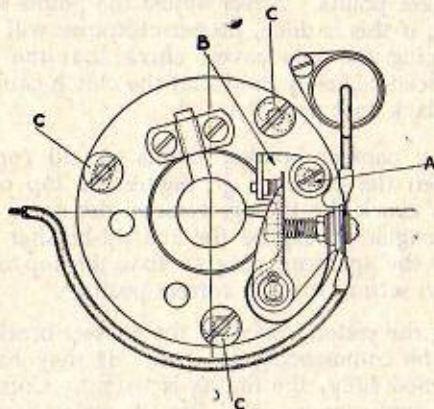

Fig. 3.—Contact-breaker assembly.

### CARBURETTER.

The Villiers Junior Carburetter, type 6/0, is used with the Mark 4.F. engine, and it should not normally be necessary to alter the setting obtained by the motor-cycle maker after road-testing.

**Operation of the Carburetter.** The function of the carburetter is to supply a mixture of petrol and air in the correct proportions, no matter what the conditions under which the engine has to work. In the Villiers carburetter (See assembly drawings in this booklet) the float chamber and float surround the jet and centre-piece, the float rising as the fuel enters the chamber until the correct level is reached. At this point a forked lever which rests on top of the float, lifts a fuel needle valve to stop the fuel supply. Fuel

enters the centrepiece through a hole in the side and passes through the calibrated jet fitted in the bottom of the centrepiece. The throttle is of a cylindrical pattern, and is fitted with a tapered needle which extends below it into the centrepiece. When the throttle, which is operated by a cable from the handlebar, closes the air supply, the largest diameter of the needle nearly closes the fuel outlet; but when the throttle is raised to admit more air, the smaller diameter of the needle allows more fuel to pass.

In this way the combination of jet size, needle position and needle taper gives a correct mixture of fuel and air at all throttle settings, making the carburetter automatic in operation. The only adjustment which can be made is to the position of the taper needle in the throttle. It is not possible to give a standard position for this needle in relation to the throttle, because each engine requires an individual adjustment.

It is not normally necessary to alter the setting of the needle, which has been determined during testing at the works. This setting controls the mixture strength from the point at which the engine is ticking over until the throttle is about two-thirds open. After this the jet controls the mixture up to full throttle position.

No alternative sizes of taper needles or jets are available, nor are they necessary for normal conditions.

### DISMANTLING THE CARBURETTER.

It is recommended that as long as the carburetter—or any other part of the engine—is giving satisfactory service, it should not be tampered with or taken to pieces. If dismantling becomes necessary, carry it out in the following way:—

**To Remove Throttle from Body.** Open the throttle to its fullest extent, and unscrew the milled ring on top of the throttle body. The throttle can now be withdrawn, but take care not to damage or bend the taper needle.

To detach the throttle from the cable, return the throttle control lever to the fully closed position, compress the throttle spring, and the inner cable can then be lifted out of its slot.

**To Remove Centrepiece and Fuel Needle from Body.** Unscrew the nut underneath the float chamber. Remove the small fibre washer, the float chamber and float, and, if loose, the fibre washer between the float chamber and the carburetter body. Remove the small locking screw situated below and to the rear of the petrol pipe union, and push the centrepiece up through the throttle bore.

**NOTE:** Do not attempt to remove the jet from the centrepiece, as these parts are not intended to be separated.

When the centrepiece is removed, the fuel needle lever is freed, and will turn to allow the fuel needle to drop out of its seating.

Therefore the fuel needle should be removed at the same time as the centrepiece, and kept in a safe place until it is required. No attempt whatever should be made to remove the fuel needle lever from the carburetter body.

**To Remove Tickler.** This should not be necessary unless the air vent hole in the carburetter body, at the base of the tickler, has become clogged. If this happens, it will no longer be possible to make a ready check on whether fuel is reaching the carburetter. Remove the tickler by taking out the split pin at its lower end, thereby releasing the tickler and its spring. One vent hole is at the bottom of the hole into which the spring fits, and the other is in the side of the tickler cap.

**Re-assembly of Carburetter.** This is the reverse of the process already described, but the following points should be observed:—

The fuel needle must be fitted into its seating point first. The fuel needle lever should then be held so that it holds the needle in place, ready for the centrepiece to be fitted between the two small prongs on the lever.

Fit the centrepiece—with the fibre washer first—so that the small locking screw can locate itself in the slot in the head of the centrepiece when it is fitted. Re-fit the locking screw.

Replace the float on the centrepiece, and check to ensure that the fuel needle lever has not become bent or damaged, allowing the float to rise too high in the float chamber.

When the float is held up against the lever, the distance between the top of the float and the carburetter body should be  $\frac{7}{32}$ ".

Replace the float chamber, not forgetting the fibre washer which goes between the chamber and the carburetter body.

Refit the float chamber retaining nut and its fibre washer to the bottom of the centrepiece, and tighten firmly. Do not over-tighten the nut, however, as this may distort the jet.

**Setting the Carburetter.** As stated already, the only adjustment which can be made to the carburetter is to the position of the taper needle in the throttle. Such adjustments should not be made unless absolutely necessary, and then only with the use of care and patience, making several small adjustments to find the best position, in preference to a single large alteration.

In this way the best possible setting can be found with the least amount of trouble.

The best setting of the taper needle is that which gives the most even two-stroking when the engine has attained its usual running temperature and is running at normal loads and speeds.

If the engine four-strokes when pulling very hard, this indicates that the mixture of fuel and air passing to the engine is too rich. As this can cause the sparking plug to oil up and stop the engine, the condition should be corrected at once.

Check that the carburetter float chamber is not flooding, and that the air cleaner is not choked.

If the four-stroking continues, the fuel and air mixture must be weakened by lowering the taper needle in the throttle.

This is done by adjusting the screw which is fitted in the centre of the top of the throttle. Turn it clockwise to lower the taper needle, and test the engine after every half-turn.

The adjusting screw is split to make it grip the hole in which it fits; take care that it does not become loose through unnecessary adjustments. Should this happen, remove the screw and prise the split portion apart VERY GENTLY, a little at a time, until it is tight enough to grip the hole properly.

**NOTE:** The taper needle must be fitted with the small spring under its head, so that it is held up against the adjusting screw.

**Carburetter Data.** The taper needle is marked  $2\frac{1}{2}$  on the parallel portion. Centrepiece and jet are marked J.120.

The normal taper needle setting measures  $\frac{3}{8}$ " from the bottom of the throttle to the end of the needle, but this should only be taken as a guide, as each engine requires individual adjustment to obtain the best results.

**ALWAYS STOP THE ENGINE BEFORE MAKING ADJUSTMENTS TO THE CARBURETTER.**

### FLYWHEEL MAGNETO AND LIGHTING SETS.

The Villiers 6-pole magneto provides current for both ignition and lighting purposes. Two types of lighting equipment are available:—

**Rectifier Lighting.** Alternating current from the lighting coils is converted to direct current by passing it through a selenium-type rectifier, and is then used for charging a 6-volt, 10 amp/hour battery. This is the standard lighting set for the Mark 4F. engine.

**Direct Lighting.** A direct lighting set is also available, in which the current from the lighting coils is taken direct to the lamps by way of the headlamp switch. Provision is made in the headlamp shell for a small dry battery (Ever-Ready type 800) to supply current for the parking lights.

The wiring diagram for the direct lighting set is given in Fig. 4 (page 14). It should be noted that it is not possible to convert a "Direct" lighting set into a "Rectifier" type, as the two sets are entirely different.

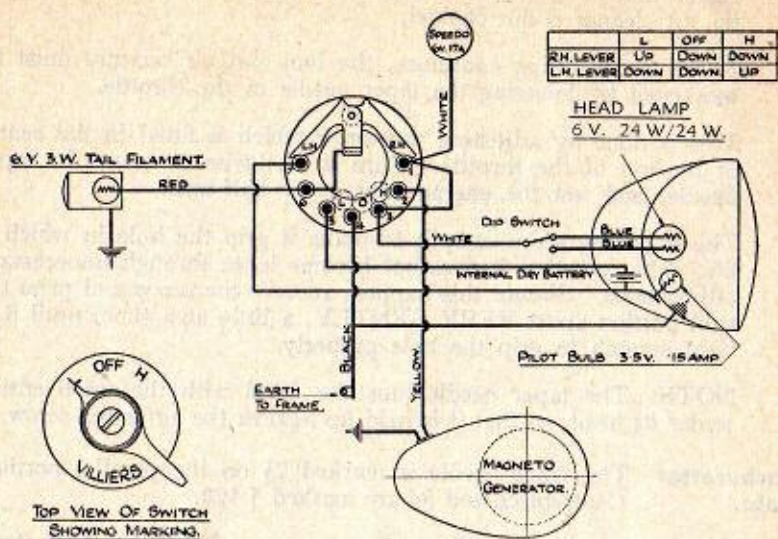

Fig. 4.—Direct type lighting set—wiring diagram.

**Care of the Rectifier Lighting Set.** The wiring connections between the battery and rectifier, and the rectifier and magneto, are given in Fig. 5 (page 15). Note that the positive side of the battery is "earthed" to the frame of the motor-cycle. The rectifier itself is hermetically sealed, and can be fitted to any part of the frame of the machine, provided that metal-to-metal contact is made with the outer plate of the rectifier, which is the earth connection of the circuit.

It should be noted that the output from the generator does not quite balance the load on the battery when the headlight is on. An electric horn and stoplight are additional loads when fitted. Therefore some daylight riding is necessary to keep the battery fully charged, without having to charge it separately.

Always make sure that the tail lamp "stop" bulb is fitted the right way round, so that the 18 watt filament lights when the foot-brake pedal is operated, and the 3 watt filament operates on the normal driving or parking circuits. If this is not the case, the battery will quickly become discharged.

- **IMPORTANT:** Should it be necessary to use the motor-cycle while the battery is removed, the lead running from the magneto to the rectifier **must** be disconnected.





The lighting leads are fastened to the lighting coils, and are led to two sockets on the clutchcase casting. If the leads have been taken out for any reason, they must be replaced so that they cannot touch the flywheel when the engine is running.

There is a clip on the armature plate, and a crevice in the clutchcase casting, and the lighting leads must be placed in these on reassembly. (See engine assembly drawings in this booklet).

## TRACING TROUBLES.

For the satisfactory running of any Villiers engine it is essential that three main conditions are fulfilled, and by making a systematic and intelligent investigation the faults can usually be located

If the engine stops, symptoms will generally give a clue to the cause, but where this is not the case, the trouble can be more easily traced by following a definite method of investigation. The three conditions mentioned above are as follows:—

(1) The required quantity of petrol-and-air mixture must enter the engine, which means that a proper supply of fuel has to be available from the carburetter, and that the throttle should open and close freely.

(2) The sparking plug must give a good spark, at the right time in relation to the position of the piston on its upward stroke

(3) The engine must be in good mechanical condition, with no air leaks at the various joints.

There must also be efficient compression of the air in the cylinder and crankcase. This can be easily checked by putting the gearbox into the neutral position, and rotating the crankshaft by means of the kickstarter. On every revolution a definite resistance should be felt, caused by the air in the cylinder being compressed.

**Making a Preliminary Check.** When the cause of the trouble is not evident, carry out a preliminary check covering the following points; if this fails to trace the cause reference should be made to the Fault Finding Chart (pages 30, 31 and 32).

Having made sure that there is "petrol" in the tank, and that the tap is in the "on" position, depress the tickler on the carburetter to ensure that there is no blockage in the fuel supply, either in the tap, fuel pipe, banjo union or fuel needle seating. If the fuel supply is clear, fuel will spurt from the vent hole in the side of the tickler cap.

Being satisfied that fuel is reaching the carburetter, next unscrew the sparking plug, and with the high tension lead still attached, lay the plug on the cylinder head. Turn the engine by means of the kickstarter, and if there is a good spark, it is possible that the ignition timing is incorrect.

Finally examine the carburetter controls to make certain that the throttle is actually opening when the control lever is moved.

## SPARE PARTS LIST—MARK 4F ENGINE.

**Note:**—When ordering spares, always quote the engine number. This is stamped on the crankcase door. **Always** quote the part number and description, not the illustration number, which is only for your assistance.

### ENGINE PARTS. Figs. 6 and 7.

**All prices in this list are subject to alteration without notice.**

ILLUS. No.	PART No.	DESCRIPTION	No. off.	PRICE EACH.		
				£	s.	d.
1	E3907	Cylinder Head Bolt	4			9
2	E5808	Washer	4			1
3	C7263	Cylinder Head	1	17		6
—	E8546	Gasket	1			5
4	B7261F/1	Cylinder	1	2	12	6
5	E4453	Exhaust Nut Washer	1			4
6	E3934	Exhaust Nut	1		3	0
7	Type 6/0	Carburettor complete with Control and Filter		2	15	0
		(See separate drawing for components)				
8	E7168	Cylinder Base Gasket	1			2
9	C7045	Piston complete with Bushes (Standard size)	1	1	2	0
—	D7515	Piston as above, .015" oversize	1	1	2	0
—	D7517	" " .030" " "	1	1	2	0
10	E6141	Piston Ring, Standard size	2		1	9
—	E7516	" " .015" oversize	2		1	9
—	E7518	" " .030" " "	2		1	9
11	E8272	Expander Ring	1		1	0
12	E7198	Gudgeon Pin	1		2	3
13	E5218	Circlip	2			3
14	D7494	Connecting Rod, .001" oversize (bushed)	1		16	0
15	E6192	Small End Bush	1		2	0
16	E7452	Rollers for Crankpin	28	Per set	4	6
17	E7493	Crankpin, .001" oversize	1		3	6
18	D7971	Crankshaft—Right-hand	1	1	10	0
19	C7875	" —Left-hand	1		17	6
20	E5124	Engine Sprocket Key	1		6	6
21	E4873	Flywheel Key	1			3
22	6205	Crankshaft Ball Bearing	2			*
23	MIS.012	Oil Seal	2		2	3
24	A3235	Gaco Oil Seal	1		3	0
25	E6725	Engine Sprocket	1		6	6
26	E7197	Lockwasher	1			4
27	E6930	Nut	1		1	0
28	110037	Primary Chain, 56 pitches	1			*
29	B7936	Crankcase Door	1	1	0	0
—	D8547	" " Gasket	1			2
30	E363	Studs for Cylinder Base	4			3
31	E1050	Spring Washer	4			1
32	E3961	Nut	4			2
33	E7271	Screw for Crankcase Door	2			4
34	E7128	" " " "	4			3
35	E3222	Crankcase Drain Plug and Clutch-bridge Bolt	2			6
36	V476	Washer, Drain Screw	1			1
37	E2924	" Plain	1			1
38	A7935	Cover, Left-hand side	1		15	0

\* Manufacturers' Current Price.

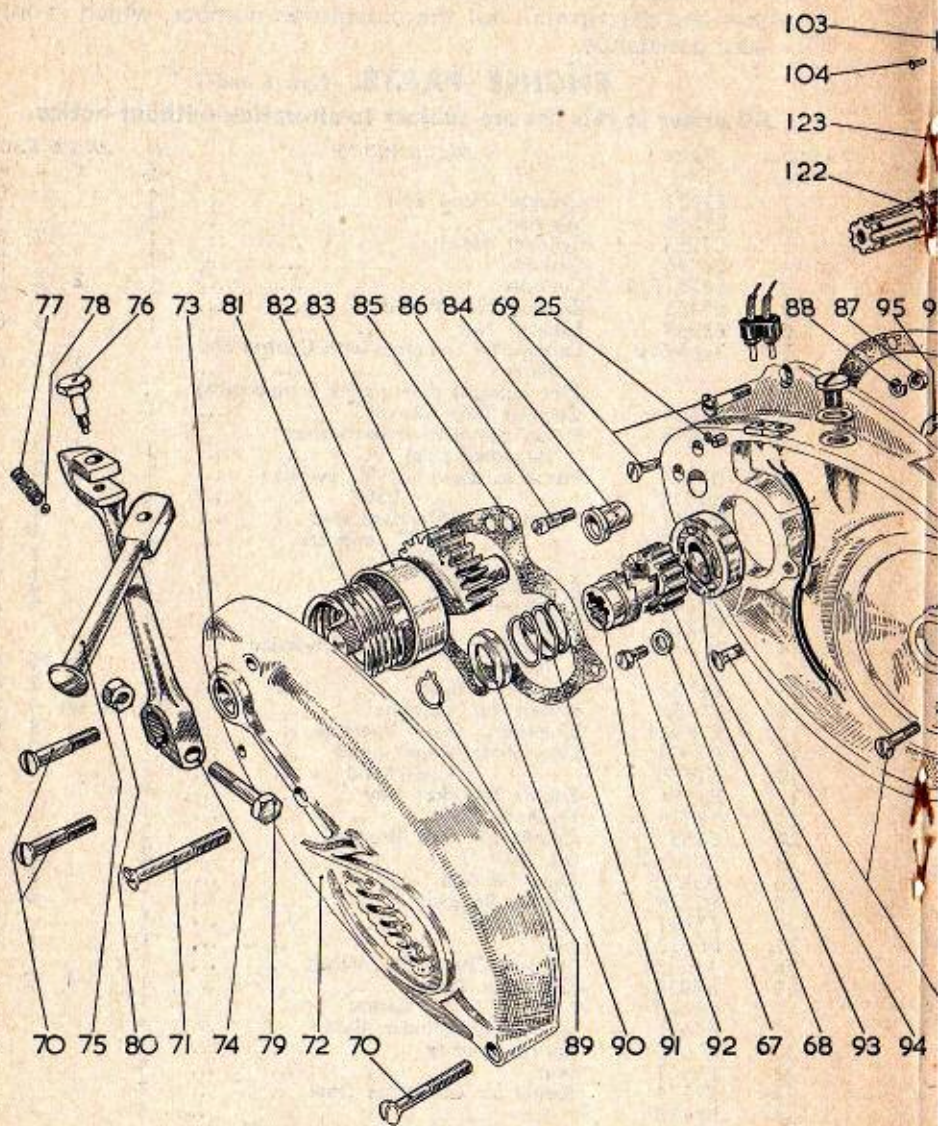
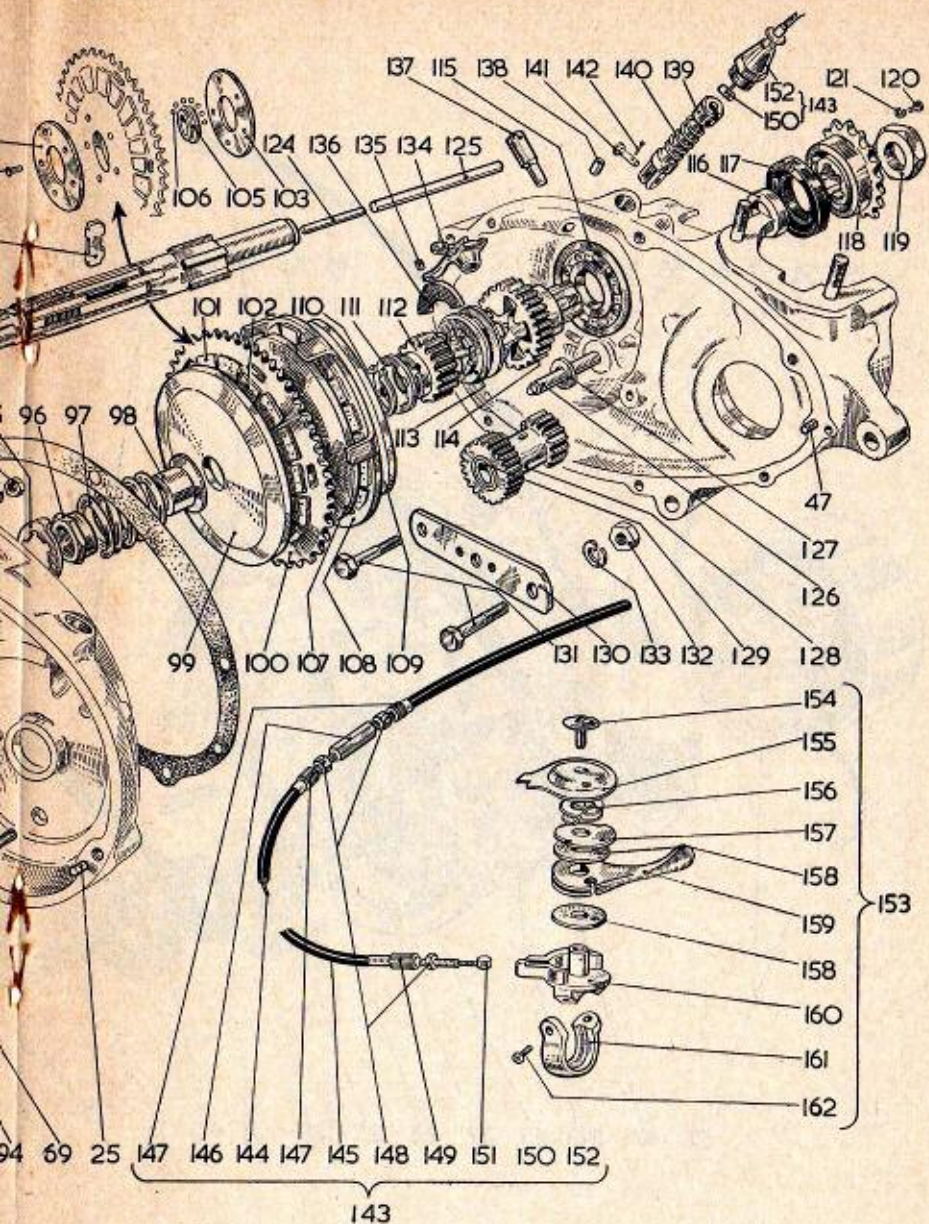

Fig. 7. ENGINE



ENGINE PARTS.

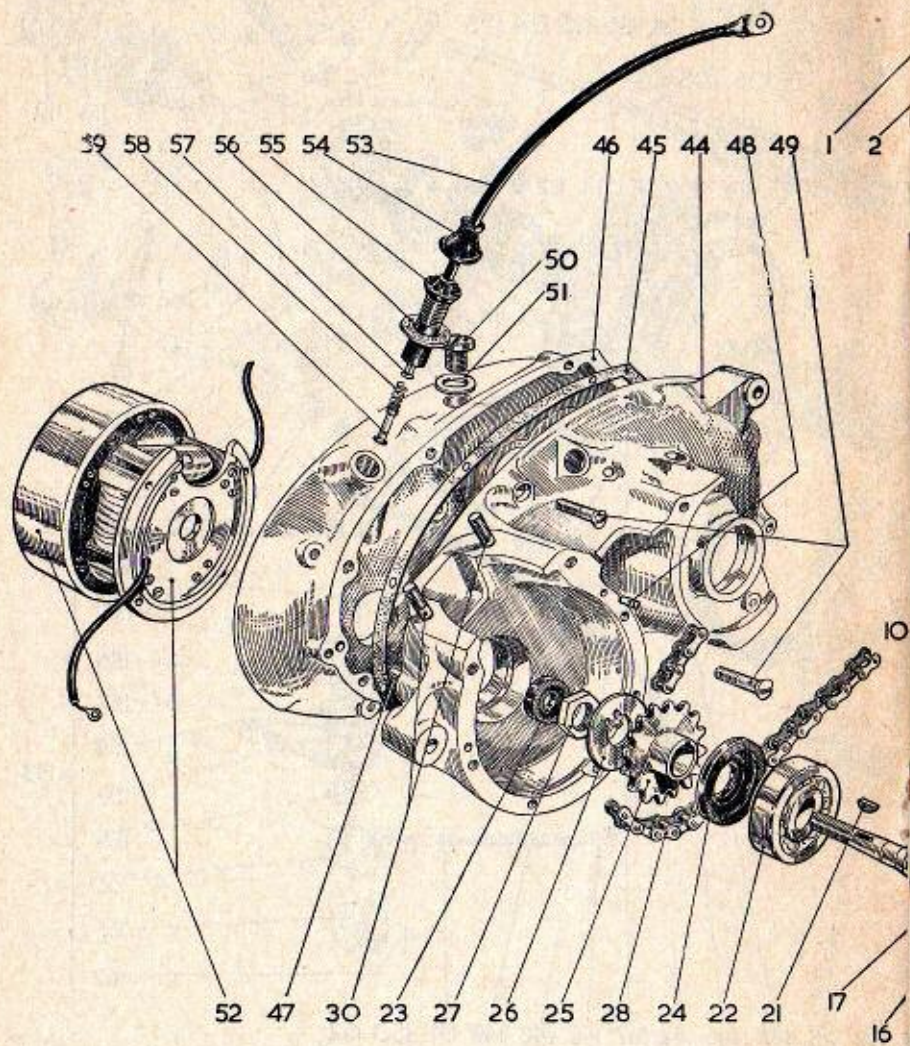
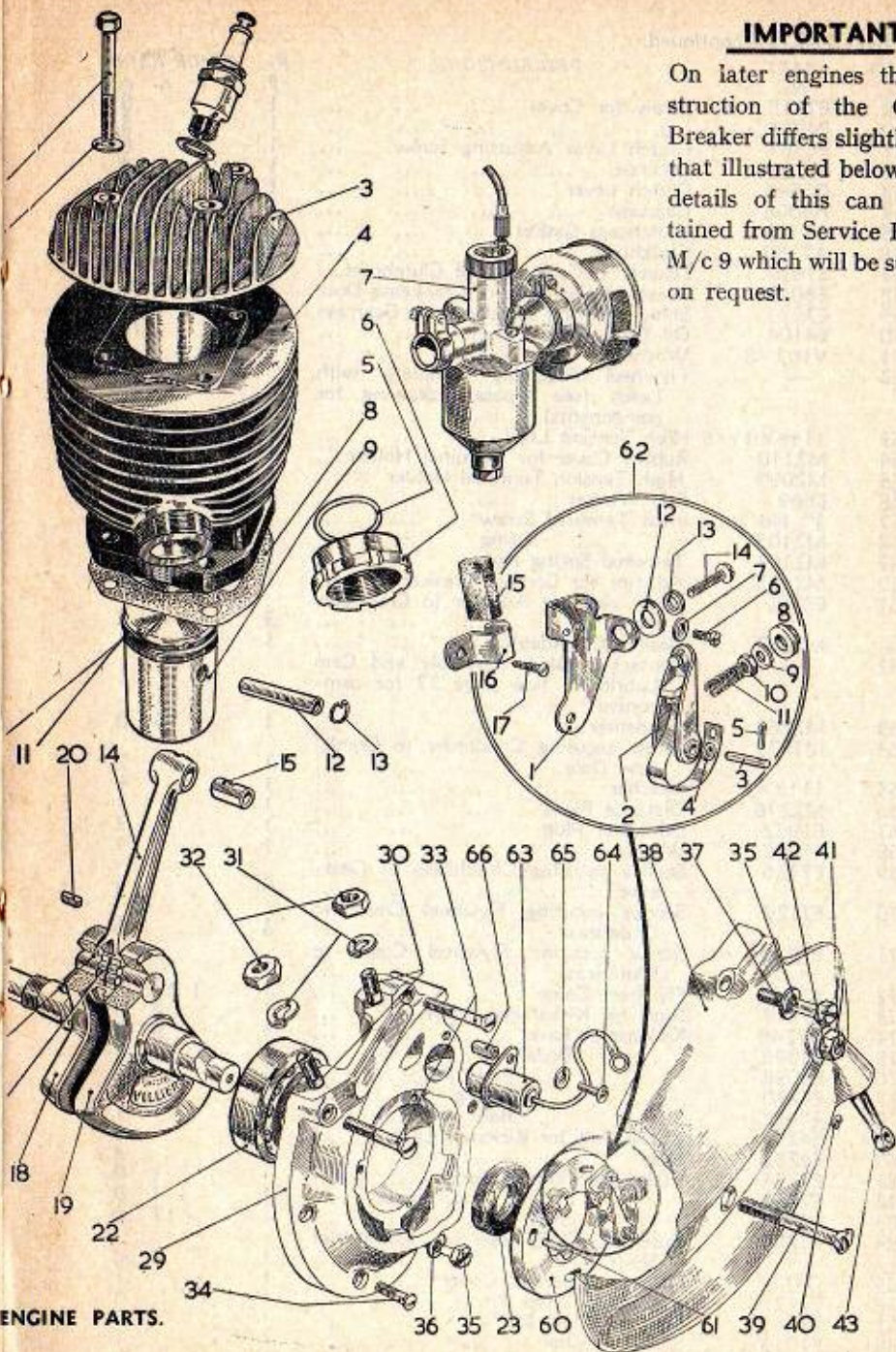

Fig. 6.

## IMPORTANT

On later engines the construction of the Contact Breaker differs slightly from that illustrated below. Full details of this can be obtained from Service Bulletin M/c 9 which will be supplied on request.



ENGINE PARTS.

**ENGINE PARTS—continued.**

ILLUS. No.	PART No.	DESCRIPTION.	No. of.	PRICE EACH.		
				£	s.	d.
39	E7915	Screw for Cover ... ..	1			5
40	E4934	" " " " " " " " " " " "	1			3
41	E6567	Clutch Lever Adjusting Screw ... ..	1			6
42	E7765	Locknut ... ..	1			4
43	D6546	Clutch Lever ... ..	1		3	0
44	A8008	Gearcase ... ..	1	2	5	0
45	C7170	Clutchcase Gasket ... ..	1			2
46	A7959	Clutchcase ... ..	1	2	5	0
47	E7619	Dowels in Gearcase and Clutchcase...	4			3
48	E8015	Dowel in Gearcase for Crankcase Door	1			2
49	E7271	Screw securing Clutchcase to Gearcase	2			4
50	E4104	Oil Filler Plug ... ..	1			10
51	V107×3	Washer ... ..	1			1
52	—	Flywheel Assembly complete with Leads (see separate drawing for components).				
53	1148×4 c/p	High Tension Lead ... ..	1	4		0
54	M2110	Rubber Cover for Terminal Holder ...	1			6
55	M2099	High Tension Terminal Holder ... ..	1	1		3
56	E869	Felt Washer ... ..	1			2
57	$\frac{3}{8}$ " No. 2	Brass Terminal Screw ... ..	1			1
58	M2105	" " Spring ... ..	1			1
59	M2104	Terminal Spring Pad ... ..	1			2
60	M2123	Adaptor for Contact Breaker ... ..	1	5		6
61	E8180	Screw securing Adaptor to Crankcase Door ... ..	3			2
—	M2368	Gasket for Adaptor ... ..	1			1
62	—	Contact Breaker Assembly and Cam Lubricator (see page 27 for components).				
63	M2262	Condenser ... ..	1	5		0
64	M1670	Screw securing Condenser to Crankcase Door ... ..	1			2
65	1113×5	Washer ... ..	1			1
66	M2276	Distance Piece ... ..	1			1
67	E1962	Oil Level Plug ... ..	1			3
68	E1905	Washer ... ..	1			1
69	E7326	Screws securing Clutchcase to Gearcase ... ..	5			3
70	E7129	Screws securing Flywheel Cover to Clutchcase ... ..	3			6
71	E7915	Screw securing Flywheel Cover to Clutchcase ... ..	1			4
72	A7960	Flywheel Cover ... ..	1	1	15	0
73	E7217	Bush for Kickstarter Shaft ... ..	1		3	3
74	D7246	Kickstarter Lever ... ..	1		9	0
75	E4096	" Pedal ... ..	1		5	0
76	E4098	" " Pivot Pin ... ..	1			7
77	E4270	" " Spring ... ..	1			1
78	$\frac{1}{2}$ " dia.	" " Ball ... ..	1			1
79	E4251	Clamp Bolt for Kickstart Lever ... ..	1			8
80	E4252	Nut ... ..	1			4
81	E7224	Kickstarter Return Spring ... ..	1		1	0
82	E7232	" " Cover ... ..	1		1	3
83	D7704	" Shaft ... ..	1	17		6
84	E7706	Bush in Clutchcase for Kickstarter Shaft ... ..	1	2		0
85	DB116	Gasket, Kickstart Cover ... ..	1			1
86	E7222	Kickstarter Stop Pin ... ..	1			3
87	E3961	Nut for Stop Pin ... ..	1			2
88	E1050	Spring Washer ... ..	1			1
89	E6552	Circlip ... ..	1			2



**ENGINE PARTS—continued.**

ILLUS.	PART No.	DESCRIPTION.	No. off.	PRICE EACH		
				£	s.	d.
90	E7221/1	Spring Retaining Washer ...	1			3
91	E7223/1	Spring ...	1			2
92	E7220/1	Kickstarter Ratchet ...	1			0
93	E7219	Pinion ...	1	6		0
94	6004	Ball Bearing ...	1	8		6
95	E7609	Splined Lockwasher ...	1			*
96	E7073	Clutch Spring Retaining Nut ...	1			3
97	E5558/1	Clutch Spring ...	1	1		0
98	E5556	" Locating Bush ...	1	1		0
99	D5433	Outer Clutch Plate, Right-hand ...	1	6		0
100	D5232	Clutch Sprocket with cork inserts ...	1	12		6
101	E4960	Large Clutch Cork for Clutch Sprocket and Corked Plate ...	25	Per Set	2	1
102	E5220	Small Clutch Cork for Clutch Sprocket only ...	5	" "		5
103	E4955	Side Plate for Clutch Sprocket Ball Bearing ...	2			5
104	E5001	Rivet for Plate ...	5	Per set		1
105	E4948	Ball Race ...	1	2		6
106	½"	Ball ...	33			6
107	D4954	Centre Clutch Plate, dished ...	1	5		6
108	D5233	Clutch Plate, with cork inserts ...	1	6		0
109	D4951	Outer Clutch Plate, Left-hand ...	1	6		0
110	E7454	Circlip ...	1			6
111	E7072	Splined Washer, brass ...	1			6
112	E7057/1	Low Gear Wheel ...	1	13		0
113	E8130	Sliding Dog Clutch ...	1	8		6
114	E7056	High Gear Wheel ...	1	19		0
115	6005	Ball Bearing ...	1			*
116	E7882	Distance Piece ...	1	2		0
117	A3235	Oil Seal ...	1	3		0
118	E7881	Driving Sprocket ...	1	7		0
119	E6930	Retaining Nut ...	1	1		0
120	E5561	Locking Screw for Retaining Nut ...	1			2
121	4 B.A.	Spring Washer ...	1			1
122	C7215	Clutch Shaft ...	1	1		0
123	E7270/1	" Cotter ...	1	2		0
124	E4945	" Push Rod, short ...	1			6
125	E7196	" " long ...	1			9
126	E7060	Countershaft Spindle ...	1	4		6
127	E7063	" Washer ...	1			9
128	E7058/1	" Bushed ...	1	17		6
129	E7061/1	" Bush ...	2	2		0
130	E7269	" Bridge ...	1	2		6
131	E4251	" Bolt ...	2			8
132	E4252	Nut ...	2			4
133	E1050	Spring Washer ...	2			1
134	E8131	Gear Selector Lever ...	1	5		0
135	E7195	Pivot Pin, Selector ...	1			3
136	E8132	Gear Operating Plate ...	1	3		0
137	E7071/1	Spindle for Selector Lever ...	1	2		0
138	E7066	Stop Pin ...	1			4
139	E7067	Forked Joint for Gear Selector ...	1	3		0
140	E7092	Gear Selector Spring ...	1			3
141	E7070	Pin securing Forked Joint to Lever ...	1			5
142	E421	Split Pin for above ...	1			1
143	C8623	Gear Selector Cable complete (com- prising items 144 to 152 inclusive)	1	8		0
144	E7491	Inner Cable (with Nipple E7199) ...	1	1		6
145	E7492	Outer Cable with Ferrules ...	1	2		6

\* Manufacturers' Current Price.

**ENGINE PARTS—continued.**

ILLUS.	PART	DESCRIPTION.	No.	PRICE EACH.
No.	No.		eff.	£ s. d.
146	E8098	Cable Adjusting Sleeve ... ..	1	9
147	V683	Locknut " Screw ... ..	2	7
148	V105×2	Locknut " ... ..	3	1
149	V105×1	Cable Adjuster at Control Lever ... ..	1	8
150	E7199	Cable Nipple at Engine end ... ..	1	3
151	E7404	" " Lever end ... ..	1	3
152	E7068	Guide " Forked Joint ... ..	1	1 6
153	E7456	Gear Control Lever Assembly (comprising items 154 to 162 inclusive)	1	10 0
154	V117×5	Screw for Gear Control Body ... ..	1	8
155	E7211	Top Cover Plate ... ..	1	6
156	V142×11	Spring Washer ... ..	1	2
157	V142×9	Friction Plate ... ..	1	6
158	V142×10	Fibre Washer ... ..	2	1
159	E7200	Gear Control Lever ... ..	1	3 0
160	V142×1	" " Body ... ..	1	3 6
161	V142×7	" " Clip ... ..	1	1 6
162	V142×5	Screw for Clip " ... ..	2	2
<b>CARBURETTER PARTS—FIG. 8.</b>				
1	V117×5	Screw for Carburetter Control Body... ..	1	8
2	V387	Top Cover Plate ... ..	1	6
3	V142×11	Spring Washer ... ..	1	2
4	V429	Friction Plate ... ..	1	6
5	V142×10	Fibre Washer ... ..	2	1
6	V406	Carburetter Control Lever ... ..	1	3 0
7	V405	" " Body ... ..	1	3 6
8	V142×7	" " Clip ... ..	1	1 6
9	V142×5	Screw for Clip " ... ..	2	2
10	V667	Control Cable Assembly (comprising items 11 to 15 inclusive)	1	5 0
11	V105×1	Control Cable Adjuster ... ..	1	8
12	V105×2	Locknut ... ..	1	1
13	V108×4	Control Cable Sleeve ... ..	1	3
14	V123×15	Nipple, Control end ... ..	1	3
15	V145×16	" Carburetter end ... ..	1	2
16	V367	Top Ring ... ..	1	1 6
17	V368	Top Disc with Guide Peg ... ..	1	2 0
18	V413	Adjuster for Taper Needle ... ..	1	6
19	V651	Taper Needle, No. 2½ ... ..	1	1 0
20	V107×7	" " Spring ... ..	1	2
21	V369	Throttle Spring ... ..	1	2
22	V365	Throttle ... ..	1	3 0
23	V408	Centrepiece with Jet, No. J.120 ... ..	1	5 0
24	V107×3	Fibre washer ... ..	1	1
25	V424	Locating Screw for Centrepiece ... ..	1	3
26	V649	Carburetter Body, with Fuel Needle Lever and Bush ... ..	1	9 6
27	V207	Tickler ... ..	1	9
28	V369	" Spring ... ..	1	2
29	V111×2	" Split Pin ... ..	1	1
30	V326	Clip securing Carburetter to Stub on Cylinder Barrel ... ..	1	2 3
31	V107×16	Screw for Clip ... ..	1	8
32	EM653	Air Filter with Clip ... ..	1	7 0
33	EM618	" Clip ... ..	1	9
34	E5102	Bolt for Clip ... ..	1	3
35	1002×15	Nut ... ..	1	2
36	V382	Banjo Union Bolt ... ..	1	1 3
37	H104×8	Washer, large hole ... ..	1	1
38	V404	Cauze Filter ... ..	1	8

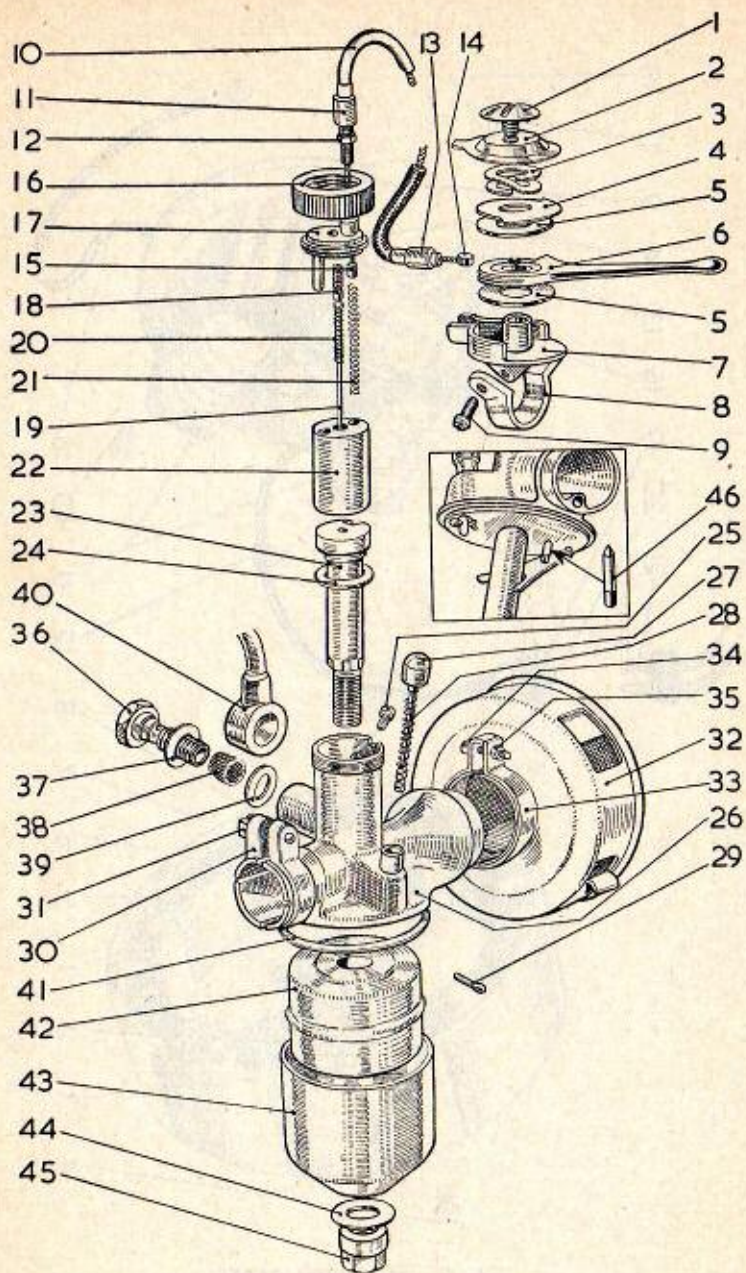

Fig. 8. CARBURETTER PARTS.

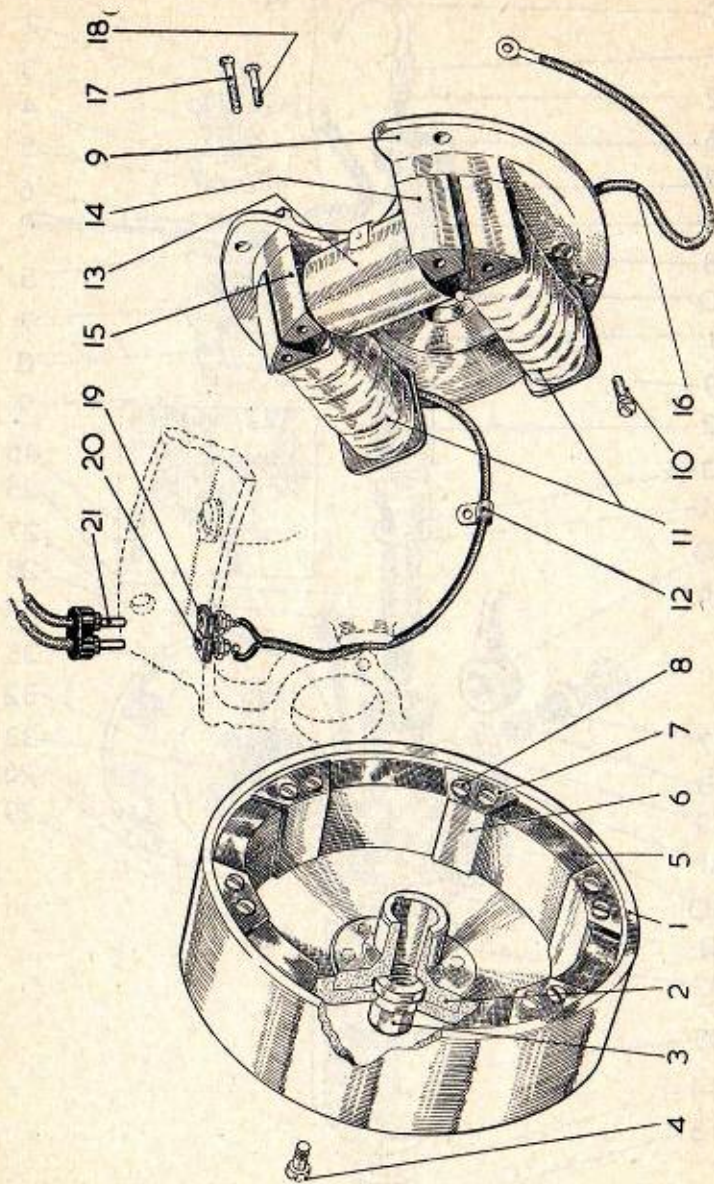

Fig. 9. MAGNETO PARTS.

**CARBURETTER PARTS—continued.**

ILLUS.	PART	DESCRIPTION.	No.	PRICE EACH.
No.	No.			£ s. d.
39	V383	Washer, small hole ... ..	1	1
40	V381	Banjo Union ... ..	1	2 0
41	V107×2	Joint Washer, Float Cup ... ..	1	2
42	V107×1	Float ... ..	1	3 6
43	V146×6	" Cup ... ..	1	2 6
44	V107×4	Washer for Bottom Nut ... ..	1	1
45	V581	Bottom Nut ... ..	1	1 3
46	V355	Fuel Needle ... ..	1	10

**CONTACT BREAKER AND CAM GREASER PARTS.**

(See item 62, Fig. 6).

1	M2118	Contact Breaker Point Bracket ... ..	1	2 0
2	M2141	Rocker Arm Assembly ... ..	1	5 0
3	M2122	" Pivot Pin ... ..	1	6
4	E5257	" " " Washer ... ..	1	1
5	V111×2	Split Pin ... ..	1	1
6	M1801	Screw for Point Bracket ... ..	1	2
7	M1802	Washer, brass ... ..	1	1
8	M2138	Low Tension Terminal Bush ... ..	1	4
9	1113×5	Washer ... ..	1	1
10	EM1001	Nut ... ..	1	2
11	1047×3	Spring ... ..	1	2
12	M1805	Insulating Washer ... ..	1	1
13	1113×5	Washer ... ..	1	1
14	M2120	Low Tension Terminal Screw ... ..	1	2
15	E8151	Felt Greaser Pad for Contact Breaker Cam ... ..	1	2
16	E8150	Clip for Greaser Pad ... ..	1	2
17	¼"×No. 4A	Screws for Clip ... ..	2	1

**MAGNETO PARTS—FIG. 9.**

1	M2156	Flywheel ... ..	1 *	5 10 0
2	M2159	" Centre ... ..	1 *	
3	M2160	" " Nut ... ..	1 *	
4	M1226	" " Screws ... ..	6 *	
R121	M2152	" Magnets ... ..	6 *	3
6	M2237	" Pole Pieces ... ..	6 *	
7	M2269	" " Plates ... ..	6	3 3
8	1002×9	" " Screws ... ..	12	
9	A128	Armature Plate Assembly ... ..	1	5 0 0
10	E5102	" " Securing Screws ... ..	4	3
11	M2346	Twin Lighting Coils complete with Leads to Sockets on Engine Casing	1 pair	1 5 0
12	M2275	Clip securing Lighting Lead to Armature Plate ... ..	1	1
13	M2151	Ignition Coil ... ..	1	1 10 0
14	M2158	" " End, R.H. ... ..	1	3 0
15	M2264	" " " L.H. ... ..	1	3 0
16	M2366	Low Tension Lead and Shoe (rubber covered cable) ... ..	1	9
17	1124×9	Screw for Ignition and Lighting Coil Ends ... ..	6	3
18	M2240	Screw for Ignition Coil Ends ... ..	2	3
19	L315	Small Socket for Lighting Lead ... ..	1	2 0
20	L316	Large " " " ... ..	1	2 0
	E8548	Locking Plate for Sockets ... ..	1	2
21	L1286	Twin Plug for Lighting Lead ... ..	1	3 0

\* Not supplied separately.

## LIGHTING SET, TYPE "A." (RECTIFIER).

PART No.	DESCRIPTION.	No. of.	PRICE EACH. £ s. d.
<b>HEAD LAMP AND FITTINGS.</b>			
BH1302	Lamp complete with Cables, Bulbs and Dip Switch ... ..	1	
SA1302/36	Lamp Body with Switch, Cables and Bulb Holders ... ..	1	
1302-44	Back Shell Assembly complete with Cable ... ..	1	
1302/31	Rim Assembly with Reflector, Clips, Glass and Cork Ring ... ..	1	
1302/43	Rim only with four Reflector Springs	1	
800/58B	Clip for Rim ... ..	1	
890-24A	Screw " " ... ..	1	
930-12	Nut ... ..	1	
1302-2	Front Glass ... ..	1	
1302-3	Reflector ... ..	1	
897-1	Wire Retaining Spring for Reflector	4	
1302-6	Cork Ring ... ..	1	
930-33C	Main Bulb Holder ... ..	1	
1185-57	Clip and Screw for Bulb Holder ...	1	
380521	Dip Switch, No. 99 ... ..	1	
380520	Clip and Screw Assembly for Dip Switch ... ..	1	
	Main Bulb: 6 volt—12/12 watt, s.b.c. ... ..	1	
	Pilot bulb: 6 volt—3 watt m.b.c. ...	1	
1302-45	Spindle Assembly, Light Switch ...	1	
SA1302-46	Switch Lever complete with Spindle and Split Pin ... ..	1	
608033	Contact for Light Switch ... ..	1	
608030	Spring " " ... ..	1	
182511	Nut for Lamp fixing " ... ..	2	
188471	Shakeproof Washer ... ..		
<b>TAIL LAMP, TYPE 477.</b>			
53182	Lamp complete with Bulb and Rubber Cover ... ..	1	
526293	Base with Bulb Holder ... ..	1	
526295	Body with Ruby Glass and Celluloid Window ... ..	1	
526286	Rubber Cover ... ..	1	
552101	Adaptor ... ..	1	
No. 190	Double Filament Bulb, s.b.c., 6 volt, 3 watt main filament. 6 volt, 18 watt stop filament ... ..	1	
<b>STOP LIGHT SWITCH.</b>			
31281	Switch complete ... ..	1	
120514	Contact Grub Screw ... ..	2	
315543	Pull Spring ... ..	1	
<b>RECTIFIER.</b>			
2L985	Westalite Rectifier ... ..	1	

## LIGHTING SET, TYPE "B." (DIRECT).

060088	Headlamp complete, M.35 ... ..	1	
608157	Rim, chrome, less Glass ... ..	1	
600308	Wire for Glass fixing ... ..	4	
612220	Packing for Glass ... ..	1	

PART No.	DESCRIPTION.	No. of.	PRICE EACH.		
			£	s.	d.
612103	Glass ... ..	1			
612171	Main Bulb Holder ... ..	1			
608025	Pilot " " ... ..	1			
612172	Reflector ... ..	1			
31157A	Lighting Switch, U39L18 ... ..	1			
31278	Dip Switch, No. 99 ... ..	1			
CM2	Cable Grommet ... ..				
182511	Lamp fixing Nut ... ..	2			
188471	Shakeproof Washer ... ..				
612218	Rim Catch Spring ... ..	1			
612217	" " ... ..	1			
188818	Terminal Sleeve ... ..				
612222	Battery Contact ... ..				
No. 180	Main Bulb, 6 volt — 18/18 watt s.b.c. ... ..	1			
No. 974	Pilot Bulb: 3.5 volt—15 amp m.e.s.	1			
993701	Cable Harness ... ..	1			
351567	Switch Handle Assembly ... ..	1			
101593	" " Screw ... ..				
	<b>TAIL LAMP, TYPE 480.</b>				
53140A	Tail Lamp, Type 480 ... ..	1			
526300	Front Assembly ... ..	1			
526317	Body Assembly ... ..	1			
526302	Rubber Grommet ... ..	1			
No. 200	Bulb, 6 volt—3 watt, s.c. ... ..	1			

## VILLIERS ENGINE SERVICE.

When a complete major overhaul becomes necessary, we will accept the old engine providing that it is complete with magneto and carburetter to our catalogue specification, and supply a fully reconditioned engine in part exchange. The reconditioned unit carries the same guarantee as a new unit. Price on application.

### REBORES.

Charge for reboring a cylinder and supplying a suitable oversize piston, providing the cylinder will clean up to either .015" O/S or .030" O/S:—£2 . 5 . 6.

### CRANKSHAFT RECONDITIONING.

When big end replacement is necessary, we will supply a reconditioned crankshaft assembly in part exchange for the original assembly, price:—£2 . 14 . 6.

### RECORKING CLUTCH.

Our standard charges for this work are as follows:—

Re-Corking Clutch Sprocket or Clutch Plate	... ..	4/6 each.
Re-Centring Clutch Sprocket	... ..	4/-

## FAULT FINDING CHART.

Sequence of Testing.	Possible Trouble.	Remedy.
<b>Engine will not start.</b>		
Depress tickler on carburetter to check whether fuel is reaching carburetter.	No fuel reaching carburetter. Air lock in petrol pipe.	Turn tap to ON, refill tank, clear air vent in filler cap. Turn on reserve tap where fitted.
If no fuel, even when tap is on and fuel is in tank.	Choked petrol pipe, filter on tap, filter in banjo. Fuel needle sticking in seating.	Remove and clean out. Dismantle carburetter and fit new needle.
Test for spark by holding sparking plug body on cylinder head.	Leak along insulation of plug or high tension lead.	Try a new plug of the type recommended and/or new H.T. lead.
If still no spark: Test for spark at end of H.T. lead held $\frac{1}{8}$ " from cylinder fins.	Plug points may be oily or sooted up. If no spark at end of H.T. lead, contact breaker point gap may be too narrow, or points pitted or dirty or oily.	Clean plug or fit new one. Adjust point gap to .015". Clean.
	Moisture on insulation of condenser.	Clean and dry out.
	High tension terminal not making good contact on ignition coil.	Clean and correct.
	Cracked insulation of adjustable contact breaker point.	Replace.
	Damaged insulating sleeving on wires connecting contact breaker to coil or condenser.	Replace with new sleeving.
	Faulty connection to low tension wire of ignition coil.	Correct.
	Faulty Condenser.	Replace.
	Faulty ignition coil.	Replace.



## FAULT FINDING CHART—(continued).

Sequence of Testing.	Possible Trouble.	Remedy.
If above tests are satisfactory, but engine will not start.	Mixture may be too rich due to use of strangler, or incorrect setting of taper needle.	Open throttle wide and depress kickstarter several times to clear engine of petrol, adjust taper needle, drain crankcase.
	Air leaks at carburettor stub or manifold joint, causing weak mixture.	Correct.
	Incorrect ignition timing.	Check, following instructions given.
<b>Engine four or eight strokes.</b>		
Strangler may not be fully open or taper needle in the "RICH" position. Air filter may need cleaning.	Mixture too rich.	Lower taper needle by moving to a WEAKER position. Lower needle by adjuster screw fitted in throttle.
Check by watching for excessive smoke from exhaust pipe or silencer.	Engine may four stroke for a little while after standing due to accumulation of oil in crankcase.	Usually ceases when engine has been running for a few minutes unless too much oil has been mixed with the petrol.
	Flooding of carburettor.	Persistent flooding is usually due to dirt under fuel needle seating, or sticking fuel needle, damaged seating or punctured float.
<b>Engine Lacks Power.</b>	Engine out of tune, bearings worn. Unsuitable sparking plug. Loss of compression.	Overhaul. Replace with recommended type. Tighten cylinder head bolts. Replace worn piston rings.
	Incorrect "petrol" mixture. Excessive carbon deposit on piston crown and cylinder head.	Correct mixture is 1 part oil, 20 parts petrol. Decarbonize.

**FAULT FINDING CHART**—(continued).

<b>Sequence of Testing.</b>	<b>Possible Trouble.</b>	<b>Remedy.</b>
	Exhaust system choked with carbon.	Clean out silencer and exhaust pipes.
	Incorrect carburetter setting.	Check and adjust.
	Air Cleaner choked.	Wash in petrol, drain and dip in thin oil.
	Obstruction in fuel supply.	Clean out tap, fuel pipe and filters.
	Incorrect ignition timing.	Check and adjust.
	Brakes binding	Adjust.
	Driving chains too tight.	Adjust.
<b>Engine will not run Slowly.</b>	Weak mixture due to air leaks at carburetter stub or manifold joint, crankcase and cylinder base joints.	Tighten all joints.
	Crankcase drain screw loose or missing.	Tighten or replace.
	Worn crankshaft bearings or leaking seal.	Replace.
	Ignition timing too far advanced.	Correct.
<b>Engine Suddenly Stops Firing.</b>	Sparking plug lead detached.	Replace and tighten nut.
	Plug points bridged by oil, carbon, or deposit caused by use of leaded petrol.	Clean or replace.
	Short circuit of high tension current by water on H.T. lead.	Dry out.

## IMPORTANT.

1.—When sending parts for replacement, repair, or as pattern, the name and address of the sender should always be securely attached. Full instructions explaining what is required should be sent separately by post. Duplicate instructions should always be enclosed with the parts.

2.—If an engine is sent for repair, it should be well packed in a strong box. Cardboard or a sack is insufficient, and engines so packed are liable to get seriously damaged in transit. Packing cases are not returnable unless specially asked for by the owner at the time of sending to us.

3.—All goods must be consigned to us carriage paid, addressed to "Service Dept." Goods returned by rail are consigned carriage paid.

4.—In correspondence, always quote the engine number, found on the crankcase door.

5.—We prefer to bench test every repaired engine before returning it to its owner. It is therefore, always advisable to send the engine complete with its magneto, sparking plug, and carburetter.

6.—When forwarding a flywheel magneto for overhaul, send the armature plate and the flywheel complete. These parts should in no circumstances be separated.

7.—Always quote the magneto number and letter(s) (if any) stamped on the face of the flywheel, when corresponding about your flywheel magneto.

8.—Old or worn-out parts sent as patterns, which we consider unserviceable are not returned unless specially asked for at the time of sending them to us.

9.—Any engines or parts sent to our Works for repair, and not paid for within six months from the date of our estimate, will be offered for sale by us elsewhere to defray expenses.

---

---

## ESTIMATES.

If required, we are always prepared to give an estimate before proceeding with any repair. This entails a certain amount of labour in dismantling to ascertain what new parts will be required, and therefore, in the case of any estimate not being accepted for special reasons, a small charge is made for our mechanics' time in taking down the parts for report.

Estimates must be treated as approximate only. We reserve the right to include additional parts should these be found, on further examination or on bench test, to be necessary, to make the repair satisfactory.

We do not undertake to fit to engines sent to us for overhaul, any parts specified by the customer when we consider that other parts are necessary to make an efficient repair. In such cases, we are prepared to supply the customers' requirements in spares, but we do not undertake to fit them.

## TERMS OF BUSINESS.

Repairs and spares must always be treated on a cash basis. Ledger accounts will be opened for items of £5 (five pounds) and upwards for approved accounts.

An extra amount must always be included in remittances to cover the cost of postage or carriage and packing on spare parts. This is 5% extra up to £5 value. Minimum extra is 6d. Stamps cannot be accepted for items over 1/- (one shilling) in value.

When making remittances by telegraph money order, the name and address of the sender must be included in the space provided on the Post Office Requisition Form for a private message from remitter to payee. Unless this is done, the Post Office does not give this information upon the telegram.

## GUARANTEE.

**W**E give the following guarantee with VILLIERS Engines and Accessories in place of any implied guarantee by statute or otherwise, all such guarantees being in all cases excluded. No statement or representation contained in this catalogue shall be construed as enlarging or varying this guarantee. In the case of engines and accessories which have been used for "hiring out" purposes, or from which our trade mark, name, or manufacturing number has been removed, no guarantee of any kind is given or is to be implied.

We guarantee, subject to the conditions mentioned below, that all precautions which are usual and reasonable have been taken by us to secure excellence of materials and workmanship, but this guarantee is to extend and to be in force for six months only from the date the engines or accessories are despatched by us, and the damages for which we make ourselves responsible under this guarantee are limited to the replacement of a part manufactured by us which may have proved defective.

We do not undertake to refit or bear the cost of replacement or refitting such new part. We guarantee, subject to the conditions mentioned below, to make good at any time within six months any defects in these respects. As VILLIERS Engines and Accessories are liable to derangement by neglect or misuse, this guarantee does not apply to defects caused by wear and tear, misuse and neglect.

### CONDITIONS OF GUARANTEE.

If a defective part should be found in our engines or accessories, it must be sent to us carriage paid and accompanied by an intimation from the sender that he desires to have it repaired free of charge, under our guarantee, and he must also furnish us at the same time with the number of the engine, and full particulars of purchase. Failing compliance with the above, no notice will be taken of anything that may arrive, but such articles will lie here at the risk of the sender, and this guarantee or any implied guarantee shall not be enforceable.

THE TERM "AGENT" is used in a complimentary sense only, and those firms whom we style our agents are not authorised to advertise, incur any debts, or transact any business whatsoever on our account other than the sale of goods which they may purchase from us, nor are they authorised to give any warranty or make any representations on our behalf or sell subject to or with any conditions other than those contained in the above guarantee.

The guarantee becomes void if any parts not made or supplied by THE VILLIERS ENGINEERING COMPANY, LTD., are fitted to a VILLIERS engine. To safeguard his own interests, the owner should always insist upon genuine VILLIERS parts.

## CONTENTS.

	Page
General Data ... ..	2
Specification ... ..	3-4
Running the engine ... ..	4-6
Before starting ... ..	4
Starting ... ..	5
On the road ... ..	6
Running-in ... ..	6
Routine attention . . . . .	7-16
Clutch and gear control cable adjustment ... ..	8
Ignition adjustment and timing ... ..	9
Carburetter ... ..	10-13
Flywheel magneto and lighting sets ... ..	13-16
Tracing troubles ... ..	16
Fault finding chart ... ..	30-32
<b>Spare parts list:—</b>	
Engine parts ... ..	17-24
Carburetter parts ... ..	24-27
Contact breaker and cam greaser parts ... ..	27
Magneto parts ... ..	27
Lighting Sets ... ..	28-29
Engine service—notes on forwarding parts—guarantee —estimates ... ..	29, 33-35

### Illustrations.

Fig. 1. Mark 4F engine, right-hand side ... ..	4
,, 2. Mark 4F engine, left-hand side ... ..	7
,, 3. Contact breaker assembly ... ..	10
,, 4. Direct type lighting set ... ..	14
,, 5. Rectifier type lighting set ... ..	15
,, 6. Engine parts ... ..	20-21
,, 7.    ,,    ,, ... ..	18-19
,, 8. Carburetter parts ... ..	25
,, 9. Magneto parts ... ..	26

*Printed in England by Barford & Newitt, Ltd., Wolverhampton.*  
B.N./10000/10/54.

*The Experience behind  
keeps* **Villiers** *in front*



## SUPPLEMENT

### ERRATA.

- Page 14.** Fig. 4. Speedometer bulb, should be 6V. 1-8W.
- Page 18 and 19.** Fig. 7. Illus. No. 25. Dowel, should be No. 47 in each case.
- Page 19.** Fig. 7. Illus. No. 113. Sliding Dog Clutch. This part is shown "back to front." The small dogs should be towards the High Gear Wheel (114) when correctly assembled.
- Page 27.** "R.121" should read "R.122."
- Page 29.** "No. 180—Main Bulb, etc." should read "No. 168—Main Bulb, 6V. 24/24W. s.b.c.—1."
- Page 29.** Prices quoted for rebores, etc., are subject to 10% increase only.
- Page 29.** The tail lamp Type 480 has now been superseded by Type 529. The bulb for the current tail lamp is Number 988 6V.-3W s.b.c. Details of other components available upon application.
- Page 35—Guarantee.** Add to second paragraph:—"We cannot accept responsibility for the replacement of proprietary articles or parts not manufactured by us, unless the makers of these parts agree to replacement."

Where Mark 4F Engines are fitted with a fan and cowling by the Machine Manufacturer, the alternative components listed below are required:

PART No.	DESCRIPTION.	REPLACES	Qty.	PRICE EACH		
				£	s.	d.
<b>R.135</b>	Flywheel complete with fan fixing screws	R.122	1	<b>5</b>	<b>10</b>	<b>0</b>
<b>B.7621G</b>	Cylinder	B.7621F/1	1	<b>2</b>	<b>12</b>	<b>6</b>
<b>C.9787</b>	Kickstart housing	A.7960	1	<b>14</b>	<b>6</b>	
<b>E.7619</b>	Dowel (1 extra for C.9787)	—	1			<b>3</b>
<b>E.9887</b>	Kickstart shaft	D.7704	1	<b>17</b>	<b>6</b>	
<b>V.1330E</b>	Carburettor elbow, with screw	Additional	1	<b>10</b>	<b>0</b>	
<b>E.5102</b>	Screw for V.1330E	"	1			<b>3</b>

### MK. 4F GEAR CONTROL.

The control illustrated below supersedes that shown on page 19. The component parts are shown overleaf and adjustment is as described on page 8.

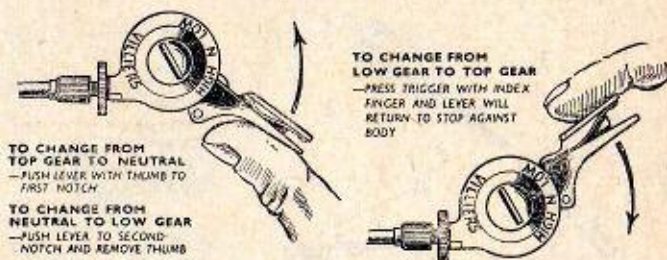

### GEAR RATIOS:—

By fitting alternative sets of Low and Countershaft Gear Wheels, two ratios are obtainable. These are:—

	COMPONENT.	PART No.	No. OF TEETH.	GEAR RATIOS.
either	Low gear wheel ...	<b>E.7057/1</b>	20	1st — 1.64 : 1
	Countershaft gear ...	<b>E.7058/1</b>	16/21	Top — 1 : 1
or	Low gear wheel ...	<b>E.7057/2</b>	20	1st — 1.715 : 1
	Countershaft gear ...	<b>E.7058/2</b>	16/22	Top — 1 : 1

**Gears must only be used in the pairs indicated above.**

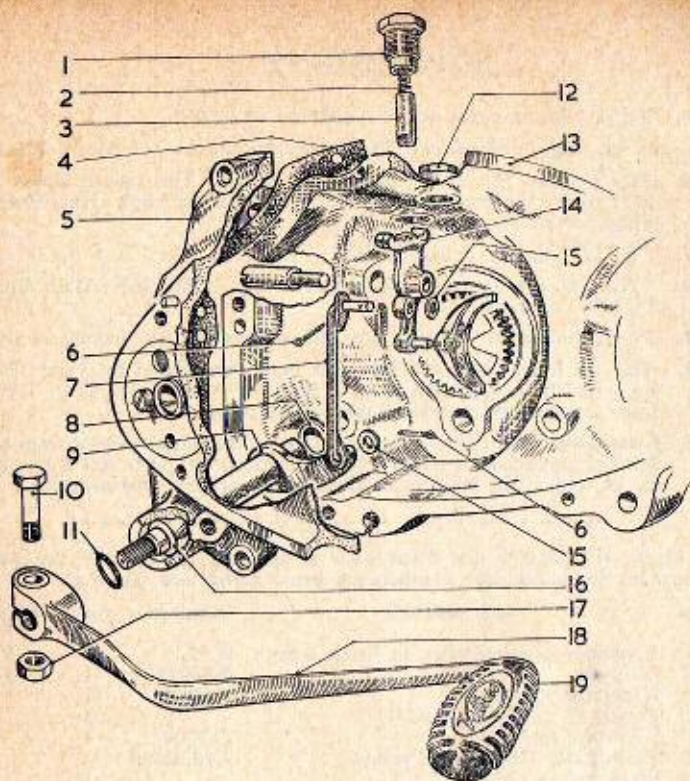

The  
of th  
duct  
new  
page  
illus

ILLUS No.
1
2
3
4
5
6
7
8
9
10
11
12
13
14
15
16
17
18
19

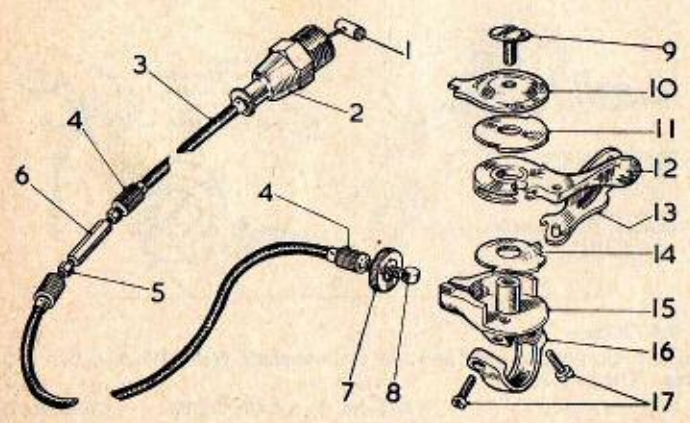

ILLUS No.
1
2
3
4
5
6
7
8
9
10
11
12
13
14
15
16
17

## MARK 6F 98 c.c. ENGINE-GEAR UNIT.

The Mark 6F Unit is fitted with a foot operated gear-change Lever, in place of the handlebar gear-change Lever fitted to the Mark 4F Engine. The introduction of the foot gear-change mechanism involves the fitting of a number of new components, details of which are shown in the illustration on the opposite page and listed, together with retail prices, below. Component parts which are illustrated, but not listed, are as for the Mark 4F Engine.

ILLUS. No.	PART No.	DESCRIPTION.	QTY.	PRICE EACH		
				£	s.	d.
1	E.9711	Plunger box	1	1	6	
2	E.9713	Plunger spring	1		3	
3	E.7209/1	Plunger	1	2	0	
4	C.9778	Clutchcase joint washer	1		2	
5	A.9700	Clutchcase, bushed	1	2	5	0
6	V.301E	Split pin	2		1	
7	E.9707/E.9708	Link rod assembly	1	2	0	
8	E.9710	Bush, in gear case	1	3	0	
9	E.9705/E.9706	Pedal shaft assembly	1	6	0	
10	E.4251	Bolt	1		8	
11	E.9987	Sealing ring	1		8	
12	E.9749	Gearcase plug	1		6	
13	A.9699	Gearcase, bushed	1	2	7	6
14	E.9703	Gear selector lever	1	6	0	
15	E.5257	Washer, for link rod	2		1	
16	E.9709	Bush, in clutch case	1	6	6	
17	E.4252	Nut	1		4	
18	D.9701	Gear-change lever	1	7	6	
19	E.9783	" " " rubber	1	1	6	

## MARK 4F RATCHET GEAR CONTROL.

ILLUS. No.	PART No.	DESCRIPTION.	QTY.	PRICE EACH		
				£	s.	d.
1	E.7199/1	Cable nipple, engine end	1		3	
2	E.7068/1	Guide for forked joint	1	1	6	
3	E.7381/1	Cable complete	1	8	0	
—	—	Control complete less cable	1	12	6	
4	V.683/1E	Adjusting screws	3		7	
5	V.105 × 2E	Lock nuts	2		1	
6	E.8098	Cable adjuster sleeve	1		9	
7	E.9135	Finger lock nut	1	1	0	
8	E.7404/1	Cable nipple, control end	1		3	
9	V.117 × 5E	Top screw	1		8	
10	E.8211	Top cover	1		6	
11	E.8210	Top plate	1		6	
12	E.8207	Control lever	1	3	6	
13	E.8208	Trigger with spring	1	1	0	
14	E.8209	Ratchet plate	1		6	
15	E.8206	Control body	1	3	6	
16	V.142 × 7E	" " clip	1	1	6	
17	V.142 × 5E	" " " screw	2		2	

All prices are subject to 20% increase from the 12th Dec., 1955.

